



Variable area flow meters

and flow switches



Great versatility with low cost alternatives

Hedland® variable area flow meters (rotameters) are the industry benchmark. This product line has grown to over 15,000 flow meters constructed of aluminium, brass or stainless steel with variable measuring area for liquids, oil, water, compressed air and many other fluids and gases. Hedland® meters are recommended for use in machine cooling and lubrication, packaging, semiconductor production, high pressure and hose applications, automotive and aviation industry as well as in the mining industry.

EZ-View®

Low cost meters for oil, water and other liquids:

- Rugged construction
- Installation in any position
- Shock and vibration resistant
- Instantaneous direct reading

Standard meters

- Variable area in-line flow meters.
- Rugged, durable construction in aluminium, brass or stainless steel
- Installation in any position
- Available from 1/4" to 2" and 3"
- Direct reading
- 360° rotatable guard scale

MR Transmitter and Flow-Alert

For fluids, air and compressed gases

- Mounting in any position
- Electronic signal output
- Digital display (MR only)
- IP 52 and 54 housings (NEMA 12/13)



Measuring principle

The variable area (rotameter) flow measurement method allows fluids (liquids and gases) volume streams to be determined. A moving sharp-edged orifice is located within the piston assembly, forming an annular opening with the contoured metering cone. The piston assembly carries a cylindrical PPS/ceramic magnet that is magnetically coupled to an external flow indicator that moves precisely in direct response to movement for the piston therefore providing a visual display for the flow rate.



Content

A great versatility of low cost alternatives	1
General design features	3
Technical information liquid & gas flow meters	4
Liquid flow meter application information	5
Pneumatic flow meter application information	6
Conversion information chart calculations and flow meter sizing (SCFM applications)	7
Conversion information chart calculations and flow meter sizing (ACFM applications)	8
Common Conversions	9
3500/6000 PSI flow meters for petroleum fluids	10
3500/6000 PSI test kits petroleum fluids	12
3500/5000 PSI test kits for petroleum fluids (1-1/4" and 1-1/2")-	14
3500/6000 PSI high temperature flow meters for petroleum fluids	16
3500/6000 PSI flow meters for phosphate ester fluids	18
3500/6000 PSI test kits for phosphate ester fluids	20
3500/5000 PSI test kits for phosphate ester fluids (1 1/4" and 1 1/2")	22
3500/6000 PSI high temperature flow meters for phosphate ester fluids	24
3500/6000 PSI flow meters for water-based fluids (water/oil emulsions)	26
3500/6000 PSI test kits for water-based fluids (water/oil emulsions)	28
3500/5000 PSI test kits for water-based fluids (water/oil emulsions) (1 1/4" and 1 1/2")	30
3500/6000 PSI high temperature flow meters for water-based fluids (water/oil emulsions)	32
3500/6000 PSI flow meters for water and other liquids	34
3500/6000 PSI high temperature	36
Flow meters for water and other liquids	36
6000 PSI flow meters for A.P.I. oil / caustic and corrosive liquids	38
1500 PSI flow meters for air / caustic and corrosive gases	40
1000/1500 PSI flow meters for air and other compressed gases	42
600 PSI test kits for air and other compressed gases	44
Flow-Alert flow switches (microswitch) for liquids / air and other compressed gases	46
Flow-Alert flow switches (reed switch) for liquids / air and other compressed gases	48
Flow-Alert flow switches (reed switch) for liquids / air and other compressed gases	49
MR Flow transmitters for liquids / air and other compressed gases	50
Flow-Alert flow switches and flow transmitters for petroleum fluids	53
Flow-Alert flow switches and flow transmitters for phosphate ester fluids	54
Flow-Alert flow switches and flow transmitters for water-based fluids (water/oil emulsions)	55
Flow-Alert flow switches and flow transmitters for water fluids	56
Flow-Alert flow switches and flow transmitters for API oil / caustic and corrosive liquids	57
Flow-Alert flow switches and flow transmitters for air / caustic and corrosive gases	58
Flow-Alert flow switches and flow transmitters for air / compressed gases	59
Digital Display for Hedland® MR flow transmitters	60
Flow vs. pressure drop petroleum fluids	62
Flow vs. pressure drop phosphate ester	63
Flow vs. pressure drop water based fluids	64
Flow vs. pressure drop water	65
Flow vs. pressure drop A.P.I. oil	66
Flow vs. pressure drop air and compressed gases	67
EZ-View® flow meters general design features	68
EZ-View® flow meters for oil and water	70
EZ-View® flow meters with Flow-Alert flow switch	72
EZ-View® flow meters for oil and water	74
EZ-View® flow meters with Flow-Alert flow switch	76
EZ-View® flow meters in-line test kits	78
Dimensional Information for standard 1½ inch C62, 3 inch; SAE, NPTF, BSPP and 3 inch C61	79
Weights for all flow meter models	80

Technical information

Liquid & gas flow meters

Repeatability within $\pm 1\%$

Flow meter repeatability is within $\pm 1\%$. This is particularly important in cyclical applications, which require consistent readings.

Operating temperature

Standard operating temperature range is -29 to $+116$ °C (-20 to $+240$ °F). High temperature flow meter range is -29 to $+204$ °C (-20 to $+400$ °F) continuous, and $+204$ to $+260$ °C ($+400$ to $+500$ °F) intermittent. Maximum operating pressure of aluminum and brass body flow meters is reduced for temperatures over 240 °F (116 °C).

Stainless steel flow meters do not require derating. Refer to pressure derating charts in the High Temperature flow meter section.

Operating pressure

Liquids: Maximum operating pressure of aluminum and brass flow meters is 241 bar (3,500 psi) in $\frac{1}{4}$ to $\frac{1}{2}$ inch sizes and 55 bar (800 psi) for 3 inch meters. Type 303 and 316 stainless steel flow meters have a 414 bar (6,000 psi) maximum operating pressure in $\frac{1}{4}$ and $\frac{1}{2}$ inch models and 345 bar (5,000 psi) maximum operating pressure in $\frac{3}{4}$ to 1 $\frac{1}{2}$ inch models. All liquid flow meters are designed with a 3:1 safety factor. High temperature affects maximum operating pressure. Refer to pressure derating charts in the High Temperature flow meter section.

Air/Gases: Maximum operating pressure of aluminum and brass flow meters is 69 bar (1,000 psi) in $\frac{1}{4}$ to $\frac{1}{2}$ inch sizes and 17 bar (250 psi) for 3 inch meters. Type 303 and 316 stainless steel flow meters have a 103 bar (1,500 psi) maximum operating pressure. All air/gas flow meters are designed with a 10:1 safety factor. All pneumatic test kits are limited to a maximum operating pressure of 41 bar (600 psi) by the control valve pressure rating. Consult factory for high pressure use.

Fatigue Rating: per NFPA T2.6.1R1-1991 - C/90
(see page 8 for further details).

Pressure drop (ΔP)

Refer to pages 62 to 67 for Flow vs. Pressure Drop data for oil, phosphate ester, water-based fluids, water, and air.

Filtration

Although Hedland® flow meters are more contamination tolerant than most fluid system components, 200 mesh (74 micron) or better filtration is required to ensure reliable performance.

Calibration

Oil, PE and WBF flow meters are calibrated with 0.876 specific gravity, 140 SUS (32cSt) hydraulic oil, irrespective of final fluid use. After calibration, PE and WBF flow meters are computer corrected for 1.18 s.g. and 1.0 s.g. respectively. Water meters are calibrated with water at 1.0 specific gravity. Air and gas meters are calibrated with air at 1.0 specific gravity (70 °F at 100 psi).



Flow meter certification

There are three (3) types of certificates available with the Hedland® flow meter:

1. Certificate of conformance
2. Calibration certificate
3. Certified drawing

Certificate of conformance: This document states that the specified Hedland® flow meter meets the performance standards indicated in the Hedland® catalog. The certificate is signed by the Corporate Quality Assurance Manager or authorized delegate and should meet most needs for performance certification.

Calibration certificate: This document contains the actual flow vs. indicated flow of a specific flow meter. It documents the error of each flow point relative to the stated tolerance limit. The master meters used to calibrate flow meters are traceable to the National Institute for Standards and Testing (NIST).

Meter type	Traceable range
Petroleum-based	0.02 to 400 GPM/0.08 to 1514 LPM
Water-based	0.02 to 325 GPM/0.08 to 1230 LPM
Air/gas	0.5 to 1000 SCFM/0.24 to 472 LPS

Certified drawings: Certified assembly prints are available and contain

1. Final meter assembly with part number and dimensions
2. Parts list by part number and description
3. Authorized drawing signatures

Reproducible ANSI A-D size drawings are available on standard bond paper. Large size drawings can also be reduced to ANSI A or B sizes. ACAD R13 and 2000 drawings can be sent by electronic format when requested.

Certificate of origin and flow meter tags also available upon request.

Note: All gallon units indicated in this catalogue are US gallons.

Liquid flow meter

Application information

Standard flow scales

Standard liquid flow scales are calibrated in gpm and lpm at 0.876 specific gravity for petroleum-based fluids, 1.18 s.g. for phosphate ester based fluids and 1.0 s.g. for water and water-based fluids. For field conversion of the standard scale to other fluids, see liquid propane example below.

Special flow scales

Special scales are available for liquids and gases in any measurement unit, and other fluid viscosities and/or specific gravities.

Viscosity effect (SUS/cSt)

Hedland®'s design utilizes a precision machined, sharp-edged orifice and biasing calibration spring that ensures operating stability and accuracy over the wide viscosity range common to many fluids. Generally, high flow models of each meter size provide good accuracy over a viscosity range of 40 to 500 SUS (4.2 to 108 cSt)

Density effect (specific gravity)

Any fluid density change from stated standards has a proportional effect on meter accuracy. Special scales can be supplied if actual specific gravity decreases accuracy beyond application limits.

Corrections for more or less dense fluids can be made to standard scales using the following correction factor:

$$\sqrt{1.0 / \text{specific gravity, for water/water-based meters}}$$

$$\sqrt{0.876 / \text{specific gravity, for petroleum-based meters}}$$

Example: Measuring liquid propane with petroleum meter

Fluid ~ Liquid Propane (LPG)

Scale Measured Flow ~ 28.5 gpm

1. Select (LPG) specific gravity from the Fluid Selection Chart = 0.51
2. Since petroleum meter is utilized, select petroleum formula
3. Divide 0.876 by 0.51 = 1.72
4. Take square root of 1.72 = 1.31 (correction factor)
5. Multiply scale reading by 1.31, 28.5 (indicated flow) x 1.31 (correction factor) = 37.3 gpm (actual flow of liquid propane)

This correction may be ignored for petroleum-based hydraulic fluids.



Fluid selection chart

Fluid	Specific Gravity	Correction factor of standard scale		Internal body material				External press. seals		Dust guard		
		Oil	Water	Aluminum	Brass	T316 SST	T303 SST	Vitron®	EPR	Polycarbonate	Nylon	Pyrex®
Acetic acid (air free)	1.06	0.909	0.971	C	N	R	R	R	R	C	N	R
Acetone	0.79	1.053	1.125	R	R	R	R	N	R	N	R	R
Alcohol butyl (butanol)	0.83	1.027	1.098	C	C	R	C	R	R	C	R	R
Alcohol ethyl (ethanol)	0.83	1.027	1.098	C	C	R	R	C	R	R	N	R
Ammonia	0.89	0.992	1.060	R	C	R	R	N	R	N	C	R
Benzene	0.69	1.127	1.204	C	R	R	C	R	N	N	R	R
Carbon disulphide	1.26	0.834	0.891	R	N	R	R	R	N	N	R	R
Castor oil	0.97	0.950	1.015	C	R	R	C	R	N	C	C	R
Cotton seed oil	0.93	0.970	1.037	C	R	R	R	R	N	R	R	R
Ethylene glycol 50/50	1.12	0.884	0.945	R	R	R	R	R	R	R	C	R
Freon II	1.46	0.774	0.828	R	R	R	R	R	N	R	R	R
Gasoline	0.70	1.119	1.195	R	R	R	R	R	N	C	R	R
Glycerin	1.26	0.834	0.891	R	R	R	R	R	R	R	C	R
Kerosene	0.82	1.033	1.104	R	R	R	R	R	N	R	R	R
Liquid propane (LPG)	0.51	1.310	1.400	R	R	R	R	R	N	N	R	R
Mineral oil	0.92	0.976	1.042	R	N	R	R	R	N	R	R	R
Naphtha	0.76	1.074	1.147	R	N	R	R	R	N	C	R	R
Perchloroethylene	1.62	0.735	0.786	C	N	R	R	R	N	N	N	R
Petroleum oil	0.876	1.000	1.068	R	R	R	R	R	N	R	R	R
Phosphate ester	1.18	0.862	0.921	R	R	R	R	N	R	N	R	R
Phosphate ester base	1.26	0.833	0.891	R	R	R	R	R	N	R	N	R
Phosphoric acid (air free)	1.78	0.701	0.749	N	N	R	N	R	N	R	N	R
Sea water	1.03	0.922	0.985	N	N	C	C	N	R	R	R	R
Synthetic petroleum base	1.00	0.936	1.000	R	C	R	R	R	N	R	R	R
Water	1.00	0.936	1.000	N	R	R	R	N	R	R	R	R
Water glycol 50/50	1.07	0.905	0.967	R	R	R	R	R	N	R	R	R
Water-in-oil	0.93	0.970	1.037	R	R	R	R	N	R	R	R	R

R - Recommended N - Not Recommended C - Consult Factory

Pneumatic flow meter

Application information

Selecting a Hedland® pneumatic flow meter

Flow meters are offered in aluminum, brass, T303 and T316 stainless steel. This wide alloy selection allows for applications from relatively benign dry compressed air to corrosive gases such as hydrogen chloride or sulfur dioxide.

Aluminum, brass and type 303 stainless steel are available in four configurations: Standard inlet and outlet ports, an extended inlet cap fitted with a pressure gauge, an extended inlet cap with a ¼ inch NPTF plugged gauge port, and a test kit with an extended inlet cap fitted with a 160 psi pressure gauge and control valve on the outlet.

Consult the factory for the configuration best suited to your application.

Standard flow rate scales - Air/Gases

The Hedland® pneumatic flow meter is offered with a standard Multi-Pressure Flow Scale.

The **Multi-Pressure Flow Scale** (figure 1) has a vertically graduated scale, calibrated for air in standard cubic feet per minute (scfm) at 1.0 s.g. (70 °F at 100 psi), or liters per second (lps) at 1.0 s.g. (21 °C at 6.9 bar). The multi-pressure scale design allows for use at line pressures from 40 to 130 psi in 10 psi increments (3.0 to 9.0 bar in 1 bar increments). This configuration requires that a pressure gauge be installed at the meter inlet.

To use, the operator reads the inlet gauge pressure and selects the appropriate vertical line or interpolated value closest to the gauge reading and follows the line until it intersects the brightly colored horizontal indicator bar.

The flow rate in scfm/lps is read by taking the intersection point and following the slope of the closest diagonal line to a scale value and interpolating the scfm/lps flow rate. No further calculations are required.

A special Single Pressure Flow Scale is available in U.S. and metric units for an additional charge. This is a graduated scale, calibrated for air in standard cubic feet per minute (scfm) at 1.0 s.g. (70 °F at 100 psi), or liters per second (lps) at 1.0 s.g. (21 °C at 6.9 bar), see figure 2, Single Pressure Flow Scale, for further details. A standard cubic foot of air is defined as a cubic foot of air at 70 °F, at atmospheric pressure 14.7 psia at sea level. Since it is impossible to flow air at “standard” conditions the scale is calibrated for an inlet condition of 100 psi (6.9 bar) at 70 °F (21 °C). A correction factor must be calculated to determine the actual air volume. Each meter is supplied with the Conversion Chart.

A specially calibrated scale for higher or lower fixed pressures in any measurement unit, and other fluid specific gravities can be supplied upon request. Consult factory for details.

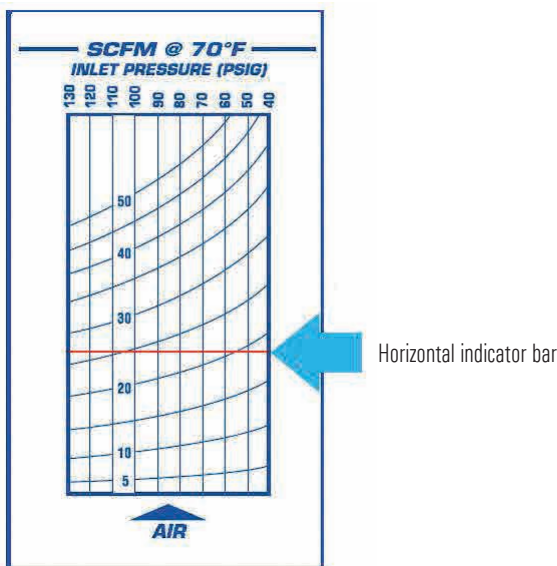

Figure 1: Multi-pressure flow scale

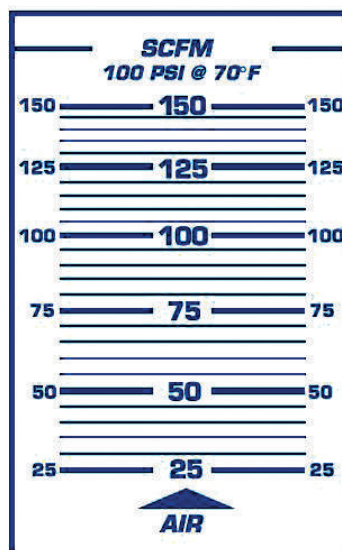

Figure 2: Single pressure flow scale

Conversion information

Chart calculations and flow meter sizing (SCFM applications)

Compressibility of gases

Since gases are significantly compressible, their density varies with pressure and temperature. Tables 1 & 2 of the conversion chart shown in figure 3 are used to convert "indicated" scfm flow rates to "actual" scfm flow rates for your application.

Effects of specific gravity

Standard scales are calibrated for air with a specific gravity of 1.0. Table 3 of the conversion chart shown in figure 3 is used to calculate "actual" scfm flow rates of gases with a specific gravity other than 1.0.

Example: Measuring natural gas with air meter

Operating parameters

- Fluid ~ Natural gas
- Line pressure ~ 140 psig
- Temperature ~ 40 °F
- Desired maximum flow ~ 85 scfm
- Pressure drop ~ 10 psiD maximum
- Port size ~ ½ inch NPTF desired

1. Pressure correction for 140 psi

$$f_1 = \sqrt{\frac{114.7}{14.7 + 140}} = \sqrt{\frac{114.7}{154.7}} = .861$$

2. Temperature correction for 40° F

$$f_2 = \sqrt{\frac{460 + 40}{530}} = \sqrt{\frac{500}{530}} = .971$$

3. Specific gravity correction for natural gas, s.g. = 0.60

$$f_3 = \sqrt{.60} = .775$$

4. Make total correction calculation. f_{total}

$$f_{total} = f_1 \times f_2 \times f_3 = .861 \times .971 \times .775 = .648$$

DETERMINE FLOW RATES USING DIFFERENT PRESSURES & TEMPERATURES

scfm (actual) = $\frac{\text{scfm (indicated)}}{f_1 \times f_2 \times f_3}$ Where f_1 = Conversion factor for inlet pressure
 f_2 = Conversion factor for temperature
 f_3 = Conversion factor for specific gravity

TABLE 1 PRESSURE CORRECTION FACTOR (f1) Operating Pressure

psig	25	50	75	100	125	150	175	200	225	250
BAR	1.7	3.5	5.2	6.9	8.6	10.4	12.1	13.8	15.5	17.2
kPa	172	345	517	689	862	1034	1207	1379	1551	1724
f1	1.700	1.331	1.131	1.00	.902	.835	.778	.731	.692	.658

$$f_1 = \sqrt{\frac{114.7}{14.7 + \text{psig}}} \quad f_1 = \sqrt{\frac{7.914}{1.014 + \text{BAR}}} \quad f_1 = \sqrt{\frac{790.857}{101.357 + \text{kPa}}}$$

TABLE 2 TEMPERATURE CORRECTION FACTOR (f2)

°F	+10	+30	+50	+70	+90	+110	+130	+150	+170	+190
°C	-12.2	-1.1	+9.9	+21.0	+32.1	+43	+54	+65	+76	+88
f2	.942	.962	.981	1.00	1.018	1.037	1.055	1.072	1.090	1.107

$$f_2 = \sqrt{\frac{460 + \text{°F}}{530}} \quad f_2 = \sqrt{\frac{273 + \text{°C}}{293}}$$

TABLE 3 SPECIFIC GRAVITY CORRECTION FACTOR (f3)

$$f_3 = \sqrt{\text{Sp. Gr.}}$$



5. To determine actual flow vs. indicated flow: read indicated flow at 100 psi vertical line on the multipressure scale (see Figure 1) and apply correction factor.

$$\text{scfm (actual)} = 55 \text{ scfm (indicated)} \times .648 (f_{total}) = 84.9$$

6. 10 psiD maximum

See page 69 for pressure drop (DP) to find the appropriate size/flow range to meet the 10 psiD requirements.

7. To determine which standard Hedland® meter is required to achieve desired maximum flow of 85 scfm.

$$85 \text{ scfm (max flow)} \times .648 (f_{total}) = 55.1 \text{ scfm}$$

8. From the example – model H671A-100 or H771A-100 can be selected. Both meet the 55.1 scfm flow requirement and operate with less than 10 psiD. The actual scale range can be calculated as follows:

$$10 \text{ scfm (standard)} \div .648 (f_{total}) = 15.4 \text{ scfm (actual)}$$

$$100 \text{ scfm (standard)} \div .648 (f_{total}) = 154.3 \text{ scfm (actual)}$$

Fluid selection chart

Fluid	Specific Gravity	Correction Factor of Standard Scale	Internal body material				External press. seals		Dust guard	
			Aluminum	Brass	T316 SST	T303 SST	Viton®	EPR	Polycarbonate	Nylon
Air	1.0	1000	R	R	R	R	R	R	R	R
Argon	1.38	1.175	R	R	R	R	R	R	R	R
Carbon dioxide (CO ₂)	1.53	1.237	R	R	R	R	R	R	R	R
Freon 11 (CCl ₃ F)	4.92	2.218	R	R	R	R	R	R	R	R
Freon 12 (CCl ₂ F)	4.26	2.060	R	R	R	R	R	R	R	R
Helium (HE)	0.14	0.374	R	R	R	R	R	R	R	R
Hydrogen (H ₂)	0.07	0.265	R	R	R	R	R	R	R	R
Natural gas	0.60	0.775	C	C	R	C	R	N	C	R
Nitrogen (N ₂)	0.97	0.985	C	C	R	R	R	R	C	R
Oxygen (O ₂)	1.10	1.049	R	R	R	R	R	R	R	R
Propane (C ₃ H ₈)	1.57	1.253	R	R	R	R	R	N	N	R

R - Recommended N - Not Recommended C - Consult Factory

Figure 4: Specific Gravity and Correction Factor for Common Gases

Figure 3: Conversion chart



Conversion information

Chart calculations and flow meter sizing (ACFM applications)

Example:

Operating parameters

Fluid ~ Air

Line pressure ~ 35 psig

Temperature ~ 70 °F

Desired maximum flow ~ 20 acfm

Since acfm measurements are not relative to the standard 1 atmosphere condition (14.7 psia), the volume of a cubic foot at 35 psig must first be related to the volume it would occupy at 1 atmosphere. The two volumes are related through Boyle's Law.

Since, $V \propto \frac{1}{P_{atm}}$, then $V_1 P_1 = V_2 P_2$, and

$$V_1 = 20 \text{ acfm}$$

$$P_1 = 35 \text{ psig} + 14.7 \text{ psig}$$

$$V_2 = \text{scfm}$$

$$P_2 = 14.7 \text{ psia}$$

$$V_2 = \frac{V_1 P_1}{P_2} = \frac{20 \times (35 + 14.7)}{14.7} = 67.62 \text{ scfm}$$

To correct for density at 35 psig; use figure 3 (tables 1, 2 & 3) on page 7.

$$f_1 = \sqrt{\frac{114.7}{14.7 + 35}} = 1.52$$

$$f_2 = 1.0$$

$$f_3 = 1.0$$

$$f_1 \times f_2 \times f_3 = 1.52 \times 1.0 \times 1.0 = 1.52 = f_{total}$$

$$V_2 \times f_{total} = \text{Hedland}^\circledast \text{ indicated flow}$$

$$67.62 \times 1.52 = 102.78 \text{ scfm indicated}$$

A Hedland[®] meter installed in this system would indicate 103 scfm. A custom calibrated scale for higher or lower fixed pressures in any measurement unit, and other fluid specific gravities can be supplied upon request.



High cycle/High pressure fatigue rating:

per NFPA/T2.6.1 R1 - 1991, C/90

The method of verifying rated fatigue pressure (or establishing the rated burst pressure, or both) of the pressure containing envelope conforms to NFPA/T2.6.1 R1, Fluid power systems and products – Method for verifying the fatigue and establishing the burst pressure ratings of the pressure containing envelope of a metal fluid power component.

Meter	Aluminum		Brass		Stainless steel	
	RFP*	Cycles	RFP*	Cycles	RFP*	Cycles
¼	2000	1 x 10 ⁶	**		3000	1 x 10 ⁶
½	2000	1 x 10 ⁶	**		3000	1 x 10 ⁶
¾	1500	1 x 10 ⁶	**		3000	1 x 10 ⁶
1	1500	1 x 10 ⁶	**		3000	1 x 10 ⁶
1¼	1000 1500	1 x 10 ⁶ 70 x 10 ³	**		3000	1 x 10 ⁶
1½	1000 1500	1 x 10 ⁶ 70 x 10 ³	**		3000	1 x 10 ⁶

* RFP = Rated Fatigue Pressure, psi

** Consult factory

Common conversions

To Convert	Into...	Multiply by...
Barrel (U.S. liquid)	Gallons	31.5
Bars	Kgs/sq meter	10,200
Bars	Pounds/sq in	14.50
Centigrade	Fahrenheit	(C° x 9.5) + 32
Cubic centimeters	Cu feet	.00003521
Cubic centimeters	Cu inches	0.06102
Cubic centimeters	Cu meters	.000001
Cubic centimeters	Gallons (U.S. liquid)	.0002642
Cubic centimeters	Liters	0.001
Cubic feet	Cu cms	28,320
Cubic feet	Cu inches	1,728
Cubic feet	Cu meters	0.02832
Cubic feet	Gallons (U.S. liquid)	7.48052
Cubic feet	Imperial gallons	6.23210
Cubic feet	Liters	28.317
Cubic feet/min	Cu cms/min	28,317
Cubic feet/min	Gallons/min	7.481
Cubic feet/min	Liters/min	28.32
Cubic feet/sec	Gallons/min	448.83
Cubic inches	Cu cms	16.39
Cubic inches	Cu feet	.0005787
Cubic inches	Cu meters	.00001639
Cubic inches	Gallons (U.S. liquid)	.004329
Cubic inches	Imperial gallons	.0036065
Cubic inches	Liters	0.01639
Cubic meters	Cu cms	1,000,000
Cubic meters	Cu feet	35.31
Cubic meters	Cu inches	61,023
Cubic meters	Gallons (U.S. liquid)	264.2
Cubic meters	Liters	1,000
Degree Fahrenheit	Degree Celsius	t °C = (t °F - 32)/1.8
Feet/min	Cms/sec	0.5080

To Convert	Into...	Multiply by...
Feet/min	Meters/min	0.3048
Gallons/min	Cu cms/min	3,785.412
Gallons/min	Cu feet/min	.1337
Gallons/min	Liters/min	3.785
Imperial gallons	Cu feet	.160459
Imperial gallons	Cu inches	277.274
Imperial gallons	Liters	4.54374
Imperial gallons	U.S. gallons	1.20032
Kilograms/sq cm	Pounds/sq ft	2,048
Kilograms/sq cm	Pounds/sq in	14.22
Kilograms/sq meter	Bars	.00009807
Kilograms/sq meter	Pounds/sq in	.001422
Liters	Cu cm	1,000
Liters	Cu feet	0.0353145
Liters	Cu inches	61.0234
Liters	Cu meters	0.001
Liters	Gallons (U.S. liquid)	0.264170
Liters	Imperial gallons	.220083
Liters/min	Cu cms/min	1000
Liters/min	Cu feet/min	.035
Liters/min	Gallons/min	.264
Pascal (Pa)	Bar	.00001
Pascal (Pa)	Pounds/sq in	.000145
Pounds/sq inch	Kgs/sq meter	703.1
Pounds/sq inch	Pascal (Pa)	6,895
Pounds/sq inch	Bar	.069
U.S. gallons	Imperial gallons	.83267
U.S. gallons	Cu cms	3785
U.S. gallons	Cu feet	.133681
U.S. gallons	Cu inches	231
U.S. gallons	Cu meters	.3785
U.S. gallons	Liters	3.785

Viscosity Conversion Table

	Saybolt Universal Seconds (SSU)	ISO-VG	CentiStoke	CentiPoise*	Typical Brands/Liquids at 100 °F
Standard Range	31	2	1.0	0.876	Water
	35	3	2.5	2.19	-
	40	5	4.2	3.68	-
	45	5/7	5.9	5.17	-
	50	7	7.5	6.57	Kerosene
	55	7/10	8.8	7.71	Atlantic Richfield/Duro 55 Hyd. Oil
	60	10	10.5	9.20	Monsanto/Skydrol - 500 A
	70	10/15	13.2	11.56	Mobil/Aero HFA Hydraulic Oil
	80	15	15.7	13.75	No 4 Fuel Oil
	90	22	18.2	15.94	Stauffer Chemical/Fyrquel 90
	100	22	20.6	18.05	Conoco/Syncon Synthetic AW Hyd. Oil
	150	32	32.0	28.03	Mobil/DTE 24 Hydraulic Oil
	200	46	43.2	37.84	Citco/Glycol FR-40XD (Oil in Water)
	300	68	65.0	56.94	SAE 20 Crankcase Oil
400	68/100	86.0	75.34	Sunoco/Sunvis 41 Hydraulic Oil	
Extended Range**	500	100	108	94.61	SAE 30 Crankcase Oil
	750	150	162	141.91	SAE 40 Crankcase Oil
	1000	220	216	189.22	Mobil/Paper Machine Oil - Type K
	1500	320	323	282.95	SAE 50 Crankcase Oil
	2000	460	431	377.56	Amoco/American Industrial Oil - No. 460
	3000	680	648	567.65	SAE 140 Gear Oil
4000	1000	862	755.11	SAE 250 Gear Oil	

* Centipoise are given for oil of 0.876 specific gravity. Relationship: centistokes x specific gravity = centipoise

** Meters measuring fluid within this range may require custom scales. Consult factory for details.

3500/6000 PSI flow meters

For petroleum fluids

- Direct reading
- Install in any position
- 360° rotatable guard/scale
- Easier-to-read linear scale
- No flow straighteners or special piping required
- Relatively insensitive to shock and vibration
- Good viscosity stability
- Temperature up to 116 °C (240 °F)
- Accuracy ±2% full scale
- Repeatability ±1%
- Special scales available
- Calibrated for .876 S.G.



Technical data

Materials	2024 - T351 anodized aluminum body, piston and cone C360 brass body, piston and conej T303 stainless body, 2024 - T351 anodized aluminum piston and cone
Common parts	Spider plate: T316 SS Spring: T302 SS Fasteners: T303 SS Guard seal / bumper: Buna N Scale support: 6063 - T6 aluminum End caps: Nylon ST Retaining ring: SAE 1070/1090 carbon steel Retaining spring: SAE 1070/1090 carbon steel Indicator and internal magnet: PPS / ceramic Pressure seals: Viton® Guard: Polycarbonate
Threads	SAE J1926-1*, NPTF ANSI B2.2, BSPP ISO1179, Code 61 and Code 62: SAEJ518
Temperature range	-29 °C to +116 °C (-20 °F to +240 °F) for higher temp. meters, see page 16-17
Pressure rating	
Aluminum / brass operating	3,500 psi/241 bar max. (800 psi/55 bar max. for 3" series) with a 3:1 safety factor. For high cycle applications: See conversion information
Stainless steel operating	6,000 psi/414 bar max. (5,000 psi/345 bar max. for ¾" to 1½" series, 4000 psi for code 62) with a 3:1 safety factor. For high cycle applications, see conversion information
Pressure drop	See ordering information table, see next page. For detailed differential pressure charts, see page 62.
Accuracy	±2% of full scale, ±7% of full scale for ¼" meters
Repeatability	±1%

* SAE ports will accept both light-duty (SAE J1926-3) and heavy-duty (SAE J1926-2) stud ends, except 1/4 (SAE 6) size, which will accept only light-duty (SAE J1926-3) studs ends.

Reverse flow by-pass option:

Features a two-piece cone that responds to flow in the primary flow direction in the same manner as the standard design. Flow in the reverse direction causes the lower cone shuttle to shift, moving it below the sharp-edged piston orifice. This shift creates a gap which allows the fluid to flow freely in the reverse direction.

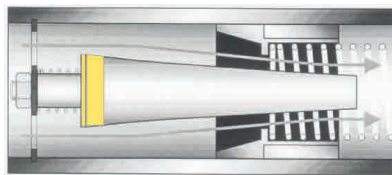

Normal flow direction

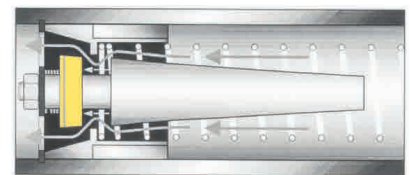

Reverse flow by-pass

Dimensions

	A	B	C	D	E	F
Nominal port size ¹	Length in (mm)	Width in (mm)	Depth in (mm)	Offset in (mm)	Flats in (mm)	
¼ (SAE 6)	4.8 (122)	1.68 (43)	1.90 (48)	.84 (21)	.88 (22)	
½ (SAE 10)	6.6 (168)	2.07 (53)	2.40 (61)	1.04 (26)	1.25 (32)	
¾ (SAE 12)	7.2 (183)	2.48 (63)	2.85 (72)	1.24 (32)	1.50 (38)	
1 (SAE 16)	7.2 (183)	2.48 (63)	2.85 (72)	1.24 (32)	1.75 (44)	
1¼ (SAE 20)	12.2 (310)	4.12 (105)	4.72 (120)	2.06 (52)	2.75 (70)	
1½ (SAE 24)	12.2 (310)	4.12 (105)	4.72 (120)	2.06 (52)	2.75 (70)	

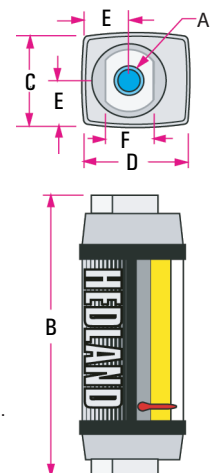

NOTE: Dimensions for 1½" Code 62, 3" and 3" Code 61 can be found on page 79.

Weights for all sizes can be found on page 80.

① 3 inch models have Celcon® piston/piston ring

3500/6000 PSI flow meters

For petroleum fluids

Ordering information

Nominal port size ^②	Flow range		Pressure drop			Model number (see example below)			Material ⌘			Options ⬥
	gal/min	l/min	50% flow psi (bar)	100% flow psi (bar)	Reverse 100% flow psi (bar)	SAE	NPTF	BSPP ^③	Aluminium 3500 psi	Brass 3500 psi	Stainless steel	Reverse flow
1/4" SAE 6	.02 - 0.2	0.1 - 0.75	3.5 (.24)	4.0 (.28)		H200 ⌘ - 002 - ⬥	H201 ⌘ - 002 - ⬥	H202 ⌘ - 002 - ⬥	A	B	6000 psi S	Not available
	.05 - 0.5	0.2 - 1.9	3.0 (.21)	5.0 (.35)		H200 ⌘ - 005 - ⬥	H201 ⌘ - 005 - ⬥	H202 ⌘ - 005 - ⬥				
	0.1 - 1.0	0.5 - 3.75	4.0 (.28)	9.0 (.62)		H200 ⌘ - 010 - ⬥	H201 ⌘ - 010 - ⬥	H202 ⌘ - 010 - ⬥				
	0.2 - 2.0	1 - 7.5	6.0 (.41)	13 (.90)		H200 ⌘ - 020 - ⬥	H201 ⌘ - 020 - ⬥	H202 ⌘ - 020 - ⬥				
1/2" SAE 10	0.1 - 1.0	0.5 - 3.75	2.0 (.14)	2.75 (.19)	5.2 (.36)	H600 ⌘ - 001 - ⬥	H601 ⌘ - 001 - ⬥	H602 ⌘ - 001 - ⬥	A	B	6000 psi S	RF
	0.2 - 2.0	1 - 7.5	2.0 (.14)	3.0 (.21)	9.6 (.66)	H600 ⌘ - 002 - ⬥	H601 ⌘ - 002 - ⬥	H602 ⌘ - 002 - ⬥				
	0.5 - 5.0	2 - 19	3.0 (.21)	6.0 (.41)	4.8 (.33)	H600 ⌘ - 005 - ⬥	H601 ⌘ - 005 - ⬥	H602 ⌘ - 005 - ⬥				
	1 - 10	5 - 38	4.0 (.28)	9.5 (.66)	23.0 (1.6)	H600 ⌘ - 010 - ⬥	H601 ⌘ - 010 - ⬥	H602 ⌘ - 010 - ⬥				
3/4" SAE 12	0.2 - 2.0	1 - 7.5	1.0 (.07)	2.0 (.14)	2.9 (.20)	H700 ⌘ - 002 - ⬥	H701 ⌘ - 002 - ⬥	H702 ⌘ - 002 - ⬥	A	B	5000 psi S	RF
	0.5 - 5.0	2 - 19	2.5 (.17)	3.5 (.24)	5.3 (.37)	H700 ⌘ - 005 - ⬥	H701 ⌘ - 005 - ⬥	H702 ⌘ - 005 - ⬥				
	1 - 10	5 - 38	3.5 (.24)	9.0 (.62)	8.8 (.61)	H700 ⌘ - 010 - ⬥	H701 ⌘ - 010 - ⬥	H702 ⌘ - 010 - ⬥				
	2 - 20	10 - 76	4.0 (.28)	9.0 (.62)	18.0 (1.24)	H700 ⌘ - 020 - ⬥	H701 ⌘ - 020 - ⬥	H702 ⌘ - 020 - ⬥				
1" SAE 16	0.2 - 2.0	1 - 7.5	1.0 (.07)	2.0 (.14)	2.9 (.20)	H760 ⌘ - 002 - ⬥	H761 ⌘ - 002 - ⬥	H762 ⌘ - 002 - ⬥	A	B	5000 psi S	RF
	0.5 - 5.0	2 - 19	2.5 (.17)	3.5 (.24)	5.3 (.37)	H760 ⌘ - 005 - ⬥	H761 ⌘ - 005 - ⬥	H762 ⌘ - 005 - ⬥				
	1 - 10	5 - 38	3.5 (.24)	9.0 (.62)	8.8 (.61)	H760 ⌘ - 010 - ⬥	H761 ⌘ - 010 - ⬥	H762 ⌘ - 010 - ⬥				
	2 - 20	10 - 76	4.0 (.28)	9.0 (.62)	18.0 (1.24)	H760 ⌘ - 020 - ⬥	H761 ⌘ - 020 - ⬥	H762 ⌘ - 020 - ⬥				
1 1/4" SAE 20	3 - 30	10 - 110	3.0 (.21)	4.0 (.28)	4.8 (.33)	H800 ⌘ - 030 - ⬥	H801 ⌘ - 030 - ⬥	H802 ⌘ - 030 - ⬥	A	B	5000 psi S	RF
	5 - 50	20 - 190	3.5 (.24)	7.0 (.48)	12.5 (.86)	H800 ⌘ - 050 - ⬥	H801 ⌘ - 050 - ⬥	H802 ⌘ - 050 - ⬥				
	10 - 75	40 - 280	5.0 (.35)	10.5 (.72)	31.9 (2.2)	H800 ⌘ - 075 - ⬥	H801 ⌘ - 075 - ⬥	H802 ⌘ - 075 - ⬥				
	10 - 100	50 - 380	6.5 (.45)	15 (1.0)	39.0 (2.7)	H800 ⌘ - 100 - ⬥	H801 ⌘ - 100 - ⬥	H802 ⌘ - 100 - ⬥				
1 1/2" SAE 24	3 - 30	10 - 110	3.0 (.21)	4.0 (.28)	4.8 (.33)	H860 ⌘ - 030 - ⬥	H861 ⌘ - 030 - ⬥	H862 ⌘ - 030 - ⬥	A	B	5000 psi S	RF
	5 - 50	20 - 190	3.5 (.24)	7.0 (.48)	12.5 (.86)	H860 ⌘ - 050 - ⬥	H861 ⌘ - 050 - ⬥	H862 ⌘ - 050 - ⬥				
	10 - 75	40 - 280	5.0 (.35)	10.5 (.72)	31.9 (2.2)	H860 ⌘ - 075 - ⬥	H861 ⌘ - 075 - ⬥	H862 ⌘ - 075 - ⬥				
	10 - 100	50 - 380	6.5 (.45)	15.0 (1.0)	39.0 (2.7)	H860 ⌘ - 100 - ⬥	H861 ⌘ - 100 - ⬥	H862 ⌘ - 100 - ⬥				
1 1/2" Code 62	3 - 30	10 - 110	3.0 (.21)	4.0 (.28)	4.8 (.33)	H808 ⌘ - 030 - ⬥			A	B	4000 psi S	RF
	5 - 50	20 - 190	3.5 (.24)	7.0 (.48)	12.5 (.86)	H808 ⌘ - 050 - ⬥						
	10 - 75	40 - 280	5.0 (.35)	10.5 (.72)	31.9 (2.2)	H808 ⌘ - 075 - ⬥						
	10 - 100	50 - 380	6.5 (.45)	15 (1.0)	39.0 (2.7)	H808 ⌘ - 100 - ⬥						
3"	10 - 200	50 - 750	11 (.76)	17 (1.1)		Not available	H901 ⌘ - 200 - ⬥	H902 ⌘ - 200 - ⬥	A	B	800 psi	Not available
	20 - 300	100 - 1100	11 (.76)	18 (1.2)			H901 ⌘ - 300 - ⬥	H902 ⌘ - 300 - ⬥				
3" Code 61	10 - 200	50 - 750	11 (.76)	17 (1.1)		H909 ⌘ - 200 - ⬥			A	B	800 psi	Not available
	20 - 300	100 - 1100	11 (.76)	18 (1.2)		H909 ⌘ - 300 - ⬥						



NOTE: RF option is not available with standard brass flow meters.

② Fractional sizes apply to NPTF and BSPP.

③ 3 inch models have BSPT (BS21) threads

3500/6000 PSI test kits

For petroleum fluids

- Direct reading
- Install in any position
- 360° rotatable guard/scale
- Easier-to-read linear scale
- No flow straighteners or special piping required
- Relatively insensitive to shock and vibration
- Good viscosity stability
- Temperature up to 116°C (240 °F)
- Accuracy ±2% full scale
- Repeatability ±1%
- Special scales available
- Calibrated for .876 S.G.



Technical data

Materials	2024 – T351 anodized aluminum body, piston and cone C360 brass body, piston and cone T303 stainless body, 2024 – T351 anodized aluminum piston and cone
Common parts	
Spider Plate: T316 SS Spring: T302 SS Fasteners: T303 SS Guard seal / bumper: Buna N Scale support: 6063 - T6 aluminum End caps: Nylon ST	Retaining ring: SAE 1070/1090 carbon steel Retaining spring: SAE 1070/1090 carbon steel Indicator and internal magnet: PPS / ceramic Pressure seals: Viton® Guard: Polycarbonate
Threads	SAE J1926/1, NPTF ANSI B2.2, BSPP ISO1179
Temperature range	-29 to +116 °C (-20 to +240 °F)
Pressure rating	
Aluminum / brass operating	3,500 psi/241 bar max. with a 3:1 safety factor. For high cycle applications: See page conversion information
Stainless steel operating:	6,000 psi/414 bar max. (5,000 psi/345 bar max. for ¾" to 1½" series) with a 3:1 safety factor. For high cycle applications, see page conversion information
Pressure drop	See ordering information table, next page and differential pressure charts on page 62.
Accuracy	±2% of full scale
Repeatability	±1%
Pressure gauge	Glycerin dampened, 0 - 3,500 psi / 0 - 240 bar pressure range available on aluminum and brass test kits. Glycerin dampened, 0 - 6,000 psi / 0 - 400 bar pressure range available on stainless steel test kits.
Load valve	½", ¾" and 1" series - needle valve; ¼" and 1½" series - ball valve. Produce ΔP up to 3,500 psi/241 bar psiD and 6,000 psi/414 bar psiD.

Dimensions

A	B	B1	C	D	E	F
Nominal port size	Length in (mm)	Length in (mm)	Width in (mm)	Depth in (mm)	Offset in (mm)	Flats in (mm)
½ (SAE 10)	6.6 (168)	10.3 (262)	2.07 (53)	2.40 (61)	1.04 (26)	1.25 (32)
¾ (SAE 12)	7.2 (183)	11.3 (287)	2.48 (63)	2.85 (72)	1.24 (32)	1.50 (38)
1 (SAE 16)	7.2 (183)	11.3 (287)	2.48 (63)	2.85 (72)	1.24 (32)	1.75 (44)

Note: Weights for all sizes can be found on page 80.
SAE and BSPP test kits include inlet adapter.

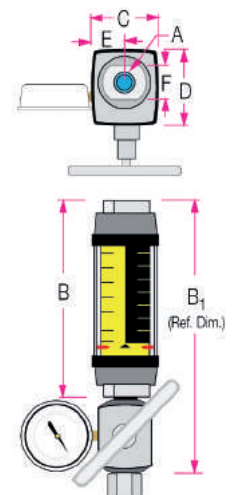

3500/6000 PSI test kits

For petroleum fluids

Ordering information

Nominal port size ^①	Flow range		Pressure drop			Model number (see example below)			Material ☒			Options
	gal/min	l/min	50% flow psi (bar)	100% flow psi (bar)	Revers 100% flow psi (bar)	SAE	NPTF	BSPB	Aluminium 3500 psi	Brass 3500 psi	Stainless steel	
½" SAE 10	0.1 - 1.0	0.5 - 3.75	3.0 (.21)	4.75 (.33)	7.2 (.50)	H600 ☒ - 001 - TK	H601 ☒ - 001 - TK	H602 ☒ - 001 - TK	A	B	6000 psi S	RT
	0.2 - 2.0	1 - 7.5	5.0 (.34)	9.0 (.62)	15.6 (1.1)	H600 ☒ - 002 - TK	H601 ☒ - 002 - TK	H602 ☒ - 002 - TK				
	0.5 - 5.0	2 - 19	10.0 (.69)	26.0 (1.8)	24.8 (1.7)	H600 ☒ - 005 - TK	H601 ☒ - 005 - TK	H602 ☒ - 005 - TK				
	1 - 10	5 - 38	24.0 (1.7)	71.5 (4.9)	85 (5.9)	H600 ☒ - 010 - TK	H601 ☒ - 010 - TK	H602 ☒ - 010 - TK				
	1 - 15	4 - 56	39.0 (2.7)	155 (10.7)	210 (14.5)	H600 ☒ - 015 - TK	H601 ☒ - 015 - TK	H602 ☒ - 015 - TK				
¾" SAE 12	0.2 - 2.0	1 - 7.5	1.5 (1.0)	3.0 (.21)	3.9 (.27)	H700 ☒ - 002 - TK	H701 ☒ - 002 - TK	H702 ☒ - 002 - TK	A	B	5000 psi S	RT
	0.5 - 5.0	2 - 19	4.0 (.28)	6.5 (.45)	8.3 (.57)	H700 ☒ - 005 - TK	H701 ☒ - 005 - TK	H702 ☒ - 005 - TK				
	1 - 10	5 - 38	6.5 (.45)	16.0 (1.1)	15.8 (1.1)	H700 ☒ - 010 - TK	H701 ☒ - 010 - TK	H702 ☒ - 010 - TK				
	2 - 20	10 - 76	11.0 (.76)	26.0 (1.8)	35.0 (2.4)	H700 ☒ - 020 - TK	H701 ☒ - 020 - TK	H702 ☒ - 020 - TK				
	3 - 30	10 - 115	18.0 (1.2)	47.5 (3.3)	76.1 (5.2)	H700 ☒ - 030 - TK	H701 ☒ - 030 - TK	H702 ☒ - 030 - TK				
1" SAE 16	0.2 - 2.0	1 - 7.5	1.5 (1.0)	3.0 (.21)	3.9 (.27)	H760 ☒ - 002 - TK	H761 ☒ - 002 - TK	H762 ☒ - 002 - TK	A	B	5000 psi S	RT
	0.5 - 5.0	2 - 19	4.0 (.28)	6.5 (.45)	8.3 (.57)	H760 ☒ - 005 - TK	H761 ☒ - 005 - TK	H762 ☒ - 005 - TK				
	1 - 10	5 - 38	6.5 (.45)	16.0 (1.1)	15.8 (1.1)	H760 ☒ - 010 - TK	H761 ☒ - 010 - TK	H762 ☒ - 010 - TK				
	2 - 20	10 - 76	11.0 (.76)	26.0 (1.8)	35.0 (2.4)	H760 ☒ - 020 - TK	H761 ☒ - 020 - TK	H762 ☒ - 020 - TK				
	3 - 30	10 - 115	18.0 (1.2)	47.5 (3.3)	76.1 (5.2)	H760 ☒ - 030 - TK	H761 ☒ - 030 - TK	H762 ☒ - 030 - TK				
	4 - 40	15 - 150	26.0 (1.8)	75.0 (5.2)	139 (9.6)	H760 ☒ - 040 - TK	H761 ☒ - 040 - TK	H762 ☒ - 040 - TK				
5 - 50	20 - 190	63.5 (4.4)	114 (7.9)	230 (15.9)	H760 ☒ - 050 - TK	H761 ☒ - 050 - TK	H762 ☒ - 050 - TK					

① Fractional sizes apply to NPTF and BSPB.

Note: TK suffix represents standard testkit configuration. For reverse flow by-pass test kit, replace TK suffix with RT suffix.

Note: RT option is not available with standard brass flow meters.

Example: H 701 A - 030 - RT

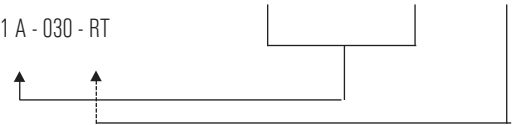

Reverse flow by-pass options

Features a two-piece cone that responds to flow in the primary flow direction in the same manner as the standard design. Flow in the reverse direction causes the lower cone shuttle to shift, moving it below the sharp-edged piston orifice. This shift creates a gap which allows the fluid to flow freely in the reverse direction.

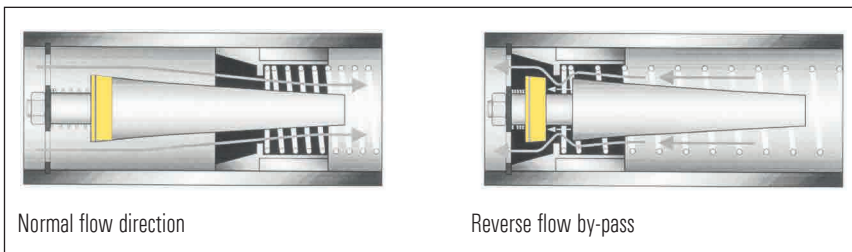

3500/5000 PSI test kits

For petroleum fluids (1 1/4" and 1 1/2")

- Direct reading
- Install in any position
- 360° rotatable guard/scale
- Easier-to-read linear scale
- No flow straighteners or special piping required
- Relatively insensitive to shock and vibration
- Good viscosity stability
- Temperature up to 116°C (240 °F)
- Accuracy ±2% full scale
- Repeatability ±1%
- Special scales available
- Calibrated for .876 S.G.



Technical data

Materials	2024 - T351 anodized aluminum body, piston and cone T303 stainless body, 2024 - T351 anodized aluminum piston and cone
Common parts	
Spider Plate: T316 SS Spring: T302 SS Fasteners: T303 SS Guard seal / bumper: Buna N Scale support: 6063 - T6 aluminum End caps: Nylon ST	Retaining ring: SAE 1070/1090 carbon steel Retaining spring: SAE 1070/1090 carbon steel Indicator and internal magnet: PPS / ceramic Pressure seals: Viton® Guard: Polycarbonate
Threads	NPT
Temperature range	-29 to +116 °C (-20 to +240 °F)
Pressure rating	
Aluminum / brass operating	3,500 psi/241 bar max. with a 3:1 safety factor. For high cycle applications: See conversion information
Stainless steel operating:	5,000 psi/345 bar max. with a 3:1 safety factor For high cycle applications, see page conversion information
Pressure drop	See ordering information table, next page and differential pressure charts on page 62.
Accuracy	±2% of full scale
Repeatability	±1%
Pressure gauge	Glycerin dampened, 0 - 3,500 psi / 0 - 240 bar pressure range available on aluminum test kits. Glycerin dampened, 0 - 5,000 psi / 0 - 345 bar pressure range available on stainless steel test kits.
Load valve	Produce ΔP up to 3,500 psi/241 bar psiD and 5,000 psi/345 bar psiD.

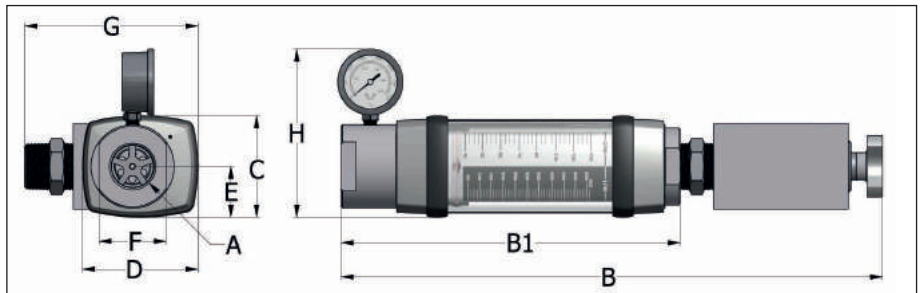

Dimensions

A	B	B1	C	D	E	F	G	H
Nominal port size	Length in (mm)	Length in (mm)	Width in (mm)	Depth in (mm)	Offset in (mm)	Flats in (mm)	Depth in (mm)	Width in (mm)
1-1/4	22.1 (561)	13.9 (353)	4.15 (105)	4.75 (121)	2.08 (53)	2.75 (70)	7.1 (180)	6.9 (175)
1-1/2	22.1 (561)	13.9 (353)	4.15 (105)	4.75 (121)	2.08 (53)	2.75 (70)	7.1 (180)	6.9 (175)

NOTE: Weights for all sizes can be found on page 80.

Pressures above 7500 psi will pop the rupture disc, allowing fluid flow to continue. This is a fail safe mechanism.

3500/5000 PSI test kits

For petroleum fluids (1 1/4" and 1 1/2")

Ordering information

Nominal port size	Flow range		Pressure drop			Model number (see example below)	Material ⌘		Options
	gal/min	l/min	50% Flow psi (bar)	100% Flow psi (bar)	Reverse 100% Flow psi (bar)	NPT	Aluminium 3500 PSI	Stainless 5000 PSI	Reverse flow
1 1/4"	3 - 30	10 - 110	3.4 (.23)	7.8 (.54)	5.6 (.39)	H TK 801 ⌘ - 030	A	S	RT
	5 - 50	20 - 190	4.3 (.30)	8.8 (6.1)	14.3 (.99)	H TK 801 ⌘ - 050			
	10 - 75	40 - 280	6.3 (.43)	14.3 (9.9)	35.7 (2.5)	H TK 801 ⌘ - 075			
	10 - 100	50 - 380	8.3 (.57)	21.3 (1.5)	45.3 (3.1)	H TK 801 ⌘ - 100			
	10 - 150	50 - 560	14.3 (.99)	41.3 (2.8)	124 (8.6)	H TK 801 ⌘ - 150			
1 1/2"	3 - 30	10 - 110	3.4 (.23)	7.8 (.54)	5.6 (.39)	H TK 861 ⌘ - 030	A	S	RT
	5 - 50	20 - 190	4.3 (.30)	8.8 (6.1)	14.3 (.99)	H TK 861 ⌘ - 050			
	10 - 75	40 - 280	6.3 (.43)	14.3 (9.9)	35.7 (2.5)	H TK 861 ⌘ - 075			
	10 - 100	50 - 380	8.3 (.57)	21.3 (1.5)	45.3 (3.1)	H TK 861 ⌘ - 100			
	10 - 150	50 - 560	14.3 (.99)	41.3 (2.8)	124 (8.6)	H TK 861 ⌘ - 150			

NOTE: TK suffix represents standard test kit configuration.
For reverse flow by-pass test kit, replace TK suffix with RT suffix.

(Example) H RT 801 A - 030

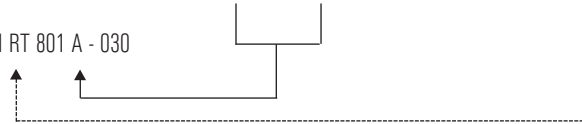

Reverse flow by-pass option: Features a two-piece cone that responds to flow in the primary flow direction in the same manner as the standard design.

Flow in the reverse direction causes the lower cone shuttle to shift, moving it below the sharp-edged piston orifice. This shift creates a gap which allows the fluid to flow freely in the reverse direction.

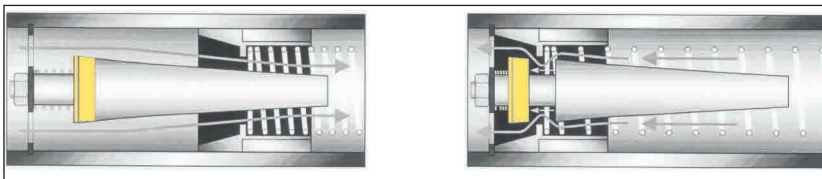

Normal flow direction

Reverse flow by-pass

3500/6000 PSI high temperature Flow meters for petroleum fluids

- Direct reading
- Install in any position
- 360° rotatable guard/scale
- Easier-to-read linear scale
- No flow straighteners or special piping required
- Relatively insensitive to shock and vibration
- Good viscosity stability
- Temperature up to 205°C (500 °F)
- Accuracy ±2% full scale
- Repeatability ±1%
- Special scales available
- Calibrated for .876 S.G.



Technical data

Materials	2024 - T351 anodized aluminum body, piston and cone C360 brass body, piston and cone T303 stainless body, 2024 - T351 anodized aluminum piston and cone
Common parts	
Spider plate: T316 SS Spring: T302 SS Fasteners: T303 SS Seals: Viton® Guard: Cylindrical Pyrex® glass Scale support: T316 SS Scale: Polyimide	Retaining ring: SAE 1070/1090 carbon steel Retaining spring: SAE 1070/1090 carbon steel Indicator: Nickel-plated carbon steel Internal magnet: Teflon® coated Alnico 8 Bumper: 2011 - T3 anodized aluminum End Caps: 2011 - T3 anodized aluminum
Threads	SAE J1926/1, NPTF ANSI B2.2, BSPP ISO1179, Code 62: SAE J518
Temperature range	-29 to +205 °C (-20 to +400 °F) continuous +205 to +260 °C (+400 to +500 °F) intermittent For detailed "Pressure vs. temperature" correlation information, see next page.
Pressure rating	
Aluminum / brass operating	3,500 psi/241 bar max. with a 3:1 safety factor. For high cycle applications, see conversion information.
Stainless steel operating	6,000 psi/414 bar max. (5,000 psi/345 bar max. for ¾" to 1½" series, 4000 psi for code 62) with a 3:1 safety factor. For high cycle applications, see conversion information.
Pressure drop	See ordering information table, next page and differential pressure charts on page 62.
Accuracy	±2% of full scale
Repeatability	±1%

Reverse flow by-pass option: Features a two-piece cone that responds to flow in the primary flow direction in the same manner as the standard design. Flow in the reverse direction causes the lower cone shuttle to shift, moving it below the sharp-edged piston orifice, which allows the fluid to flow freely in the reverse direction.

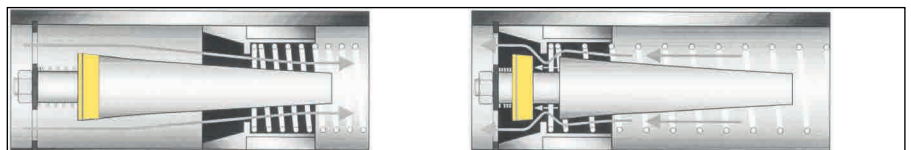

Normal flow direction

Reverse flow by-pass

Dimensions

A	B	C	D
Nominal port size	Length in (mm)	Width in (mm)	Flats in (mm)
¼ (SAE 6)	6.60 (168)	2.01 (53)	1.25 (32)
½ (SAE 10)	6.60 (168)	2.01 (53)	1.25 (32)
¾ (SAE 12)	7.20 (183)	2.48 (63)	1.50 (38)
1 (SAE 16)	7.20 (183)	2.48 (63)	1.75 (44)
1¼ (SAE 20)	12.20 (310)	4.20 (105)	2.75 (70)
1½ (SAE 24)	12.20 (310)	4.20 (105)	2.75 (70)

NOTE: Dimensions for 1½" Code 62 can be found on page 79.
Weights for all sizes can be found on page 80.

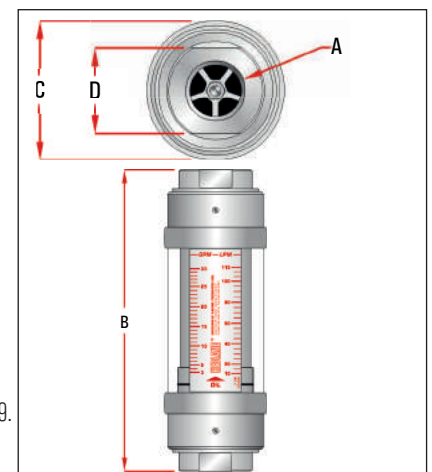

3500/6000 PSI high temperature

Flow meters for petroleum fluids

Ordering information

Nominal port size ^①	Flow range		Pressure drop			Model number (see example below)			Material ⌘			Options
	gal/min	l/min	50% flow psi (bar)	100% flow psi (bar)	Reverse 100% flow psi (bar)	SAE	NPTF	BSPP	Aluminium 3500 psi	Brass 3500 psi	Stainless steel	Reverse flow
¼" SAE 6	0.1 - 1.0	0.5 - 3.75	4.0 (.28)	9.0 (.62)		H200 ⌘ - 010 - HT	H201 ⌘ - 010 - HT	H202 ⌘ - 010 - HT	A	B	6000 psi S	Not available
	0.2 - 2.0	1.0 - 7.5	6.0 (.41)	13 (.90)		H200 ⌘ - 020 - HT	H201 ⌘ - 020 - HT	H202 ⌘ - 020 - HT				
½" SAE 10	0.1 - 1.0	0.5 - 3.75	2.0 (.14)	2.75 (.19)	5.2 (.36)	H600 ⌘ - 001 - HT	H601 ⌘ - 001 - HT	H602 ⌘ - 001 - HT	A	B	6000 psi S	HR
	0.2 - 2.0	1.0 - 7.5	2.0 (.14)	3.0 (.21)	9.6 (.66)	H600 ⌘ - 002 - HT	H601 ⌘ - 002 - HT	H602 ⌘ - 002 - HT				
	0.5 - 5.0	2 - 19	3.0 (.21)	6.0 (.41)	4.8 (.33)	H600 ⌘ - 005 - HT	H601 ⌘ - 005 - HT	H602 ⌘ - 005 - HT				
	1 - 10	5 - 38	4.0 (.28)	9.5 (.66)	23.0 (1.6)	H600 ⌘ - 010 - HT	H601 ⌘ - 010 - HT	H602 ⌘ - 010 - HT				
¾" SAE 12	1 - 15	4 - 56	6.5 (.45)	18.5 (1.3)	55.2 (3.8)	H600 ⌘ - 015 - HT	H601 ⌘ - 015 - HT	H602 ⌘ - 015 - HT	A	B	5000 psi S	HR
	0.2 - 2.0	1 - 7.5	1.0 (.07)	2.0 (.14)	2.9 (.20)	H700 ⌘ - 002 - HT	H701 ⌘ - 002 - HT	H702 ⌘ - 002 - HT				
	0.5 - 5.0	2 - 19	2.5 (.17)	3.5 (.24)	5.3 (.37)	H700 ⌘ - 005 - HT	H701 ⌘ - 005 - HT	H702 ⌘ - 005 - HT				
	1 - 10	5 - 38	3.5 (.24)	9.0 (.62)	8.8 (.61)	H700 ⌘ - 010 - HT	H701 ⌘ - 010 - HT	H702 ⌘ - 010 - HT				
	2 - 20	10 - 76	4.0 (.28)	9.0 (.62)	18.0 (1.24)	H700 ⌘ - 020 - HT	H701 ⌘ - 020 - HT	H702 ⌘ - 020 - HT				
1" SAE 16	3 - 30	10 - 115	7.0 (.48)	16.5 (1.1)	45.1 (3.11)	H700 ⌘ - 030 - HT	H701 ⌘ - 030 - HT	H702 ⌘ - 030 - HT	A	B	5000 psi S	HR
	0.2 - 2.0	1 - 7.5	1.0 (.07)	2.0 (.14)	2.9 (.20)	H760 ⌘ - 002 - HT	H761 ⌘ - 002 - HT	H762 ⌘ - 002 - HT				
	0.5 - 5.0	2 - 19	2.5 (.17)	3.5 (.24)	5.3 (.37)	H760 ⌘ - 005 - HT	H761 ⌘ - 005 - HT	H762 ⌘ - 005 - HT				
	1 - 10	5 - 38	3.5 (.24)	9.0 (.62)	8.8 (.61)	H760 ⌘ - 010 - HT	H761 ⌘ - 010 - HT	H762 ⌘ - 010 - HT				
	2 - 20	10 - 76	4.0 (.28)	9.0 (.62)	18.0 (1.24)	H760 ⌘ - 020 - HT	H761 ⌘ - 020 - HT	H762 ⌘ - 020 - HT				
	3 - 30	10 - 115	7.0 (.48)	16.5 (1.1)	45.1 (3.11)	H760 ⌘ - 030 - HT	H761 ⌘ - 030 - HT	H762 ⌘ - 030 - HT				
1½" SAE 20	4 - 40	15 - 150	9.0 (.62)	24.0 (1.7)	87.5 (6.04)	H760 ⌘ - 040 - HT	H761 ⌘ - 040 - HT	H762 ⌘ - 040 - HT	A	B	5000 psi S	HR
	5 - 50	20 - 190	12.5 (.86)	34.0 (2.3)	150 (10.4)	H760 ⌘ - 050 - HT	H761 ⌘ - 050 - HT	H762 ⌘ - 050 - HT				
	3 - 30	10 - 110	3.0 (.21)	4.0 (.28)	4.8 (.33)	H800 ⌘ - 030 - HT	H801 ⌘ - 030 - HT	H802 ⌘ - 030 - HT				
	5 - 50	20 - 190	3.5 (.24)	7.0 (.48)	12.5 (.86)	H800 ⌘ - 050 - HT	H801 ⌘ - 050 - HT	H802 ⌘ - 050 - HT				
	10 - 75	40 - 280	5.0 (.35)	10.5 (.72)	31.9 (2.2)	H800 ⌘ - 075 - HT	H801 ⌘ - 075 - HT	H802 ⌘ - 075 - HT				
1½" SAE 24	10 - 100	50 - 380	6.5 (.45)	15 (1.0)	39.0 (2.7)	H800 ⌘ - 100 - HT	H801 ⌘ - 100 - HT	H802 ⌘ - 100 - HT	A	B	4000 psi S	HR
	10 - 150	50 - 560	10.5 (.72)	27.5 (1.9)	110 (7.6)	H800 ⌘ - 150 - HT	H801 ⌘ - 150 - HT	H802 ⌘ - 150 - HT				
	3 - 30	10 - 110	3.0 (.21)	4.0 (.28)	4.8 (.33)	H860 ⌘ - 030 - HT	H861 ⌘ - 030 - HT	H862 ⌘ - 030 - HT				
	5 - 50	20 - 190	3.5 (.24)	7.0 (.48)	12.5 (.86)	H860 ⌘ - 050 - HT	H861 ⌘ - 050 - HT	H862 ⌘ - 050 - HT				
	10 - 75	40 - 280	5.0 (.35)	10.5 (.72)	31.9 (2.2)	H860 ⌘ - 075 - HT	H861 ⌘ - 075 - HT	H862 ⌘ - 075 - HT				
1½" Code 62	10 - 100	50 - 380	6.5 (.45)	15 (1.0)	39.0 (2.7)	H860 ⌘ - 100 - HT	H861 ⌘ - 100 - HT	H862 ⌘ - 100 - HT	A	B	4000 psi S	HR
	10 - 150	50 - 560	10.5 (.72)	27.5 (1.9)	110 (7.6)	H860 ⌘ - 150 - HT	H861 ⌘ - 150 - HT	H862 ⌘ - 150 - HT				
	3 - 30	10 - 110	3.0 (.21)	4.0 (.28)	4.8 (.33)	H808 ⌘ - 030 - HT						
	5 - 50	20 - 190	3.5 (.24)	7.0 (.48)	12.5 (.86)	H808 ⌘ - 050 - HT						
	10 - 75	40 - 280	5.0 (.35)	10.5 (.72)	31.9 (2.2)	H808 ⌘ - 075 - HT						

① Fractional sizes apply to NPTF and BSPP.

Note: HT suffix represents standard high temperature configuration. For reverse flow high temperature, replace HT with HR suffix.

Note: HR option is not available with brass flow meters.

Example: H 701 A - 030 - HR

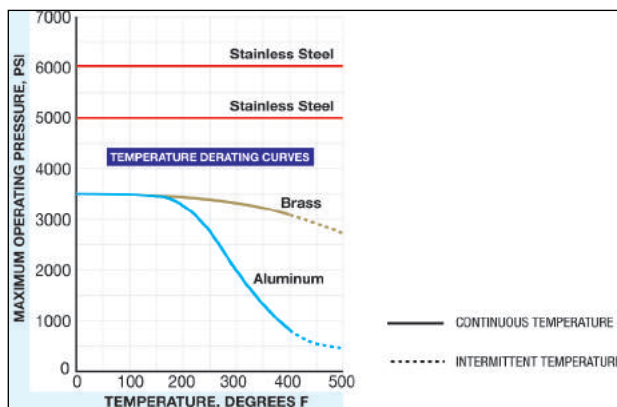

3500/6000 PSI flow meters

For phosphate ester fluids

- Direct reading
- Install in any position
- 360° rotatable guard/scale
- Easier-to-read linear scale
- No flow straighteners or special piping required
- Relatively insensitive to shock and vibration
- Good viscosity stability
- Temperature up to 116°C (240 °F)
- Accuracy ±2% full scale
- Repeatability ±1%
- Special scales available
- Calibrated for 1.18 S.G.



Technical data

Materials	2024 - T351 anodized aluminum body, piston and cone C360 brass body, piston and cone T303 stainless body, 2024 - T351 anodized aluminum piston and cone
Common parts	
Spider plate: T316 SS Spring: T302 SS Fasteners: T303 SS Pressure seals: EPR Guard: Nylon End caps: Nylon ST	Retaining ring: SAE 1070/1090 carbon steel Retaining spring: SAE 1070/1090 carbon steel Indicator and internal magnet: PPS / ceramic Guard seal / bumper: EPR Scale support: 6063 - T6 aluminum
Threads	SAE J1926/1, NPTF ANSI B2.2, BSPP ISO1179, code 62: SAE J518
Temperature range	-29 to +116 °C (-20 to +240 °F) for higher temp. meters, see page 24-25.
Pressure rating	-
Aluminum / brass operating	3,500 psi/241 bar max. with a 3:1 safety factor. For high cycle applications: See page conversion information
Stainless steel operating	6,000 psi/414 bar max. (5,000 psi/345 bar max. for ¼" to 1½" series, 4000 psi for code 62) with a 3:1 safety factor. For high cycle applications: See page conversion information
Pressure drop:	See ordering information table, next page and detailed differential pressure charts on page 62.
Accuracy	±2% of full scale, ±7% of full scale for ¼" meters
Repeatability	±1%

Reverse flow by-pass option: Features a two-piece cone that responds to flow in the primary flow direction in the same manner as the standard design.

Flow in the reverse direction causes the lower cone shuttle to shift, moving it below the sharp-edged piston orifice. This shift creates a gap which allows the fluid to flow freely in the reverse direction.

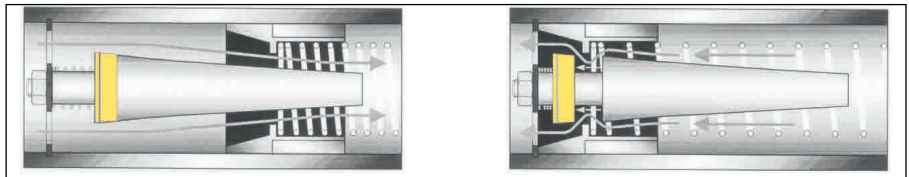

Normal flow direction

Reverse flow by-pass

Dimensions

A	B	C	D	E	F
Nominal port size	Length in (mm)	Width in (mm)	Depth in (mm)	Offset in (mm)	Flats in (mm)
¼ (SAE 6)	4.8 (122)	1.68 (43)	1.90 (48)	.84 (21)	.88 (22)
½ (SAE 10)	6.6 (168)	2.07 (53)	2.40 (61)	1.04 (26)	1.25 (32)
¾ (SAE 12)	7.2 (183)	2.48 (63)	2.85 (72)	1.24 (32)	1.50 (38)
1 (SAE 16)	7.2 (183)	2.48 (63)	2.85 (72)	1.24 (32)	1.75 (44)
1¼ (SAE 20)	12.2 (310)	4.12 (105)	4.72 (120)	2.06 (52)	2.75 (70)
1½ (SAE 24)	12.2 (310)	4.12 (105)	4.72 (120)	2.06 (52)	2.75 (70)

Note: Dimensions for 1-½" Code 62 can be found on page 79.

Weights for all sizes can be found on page 80.

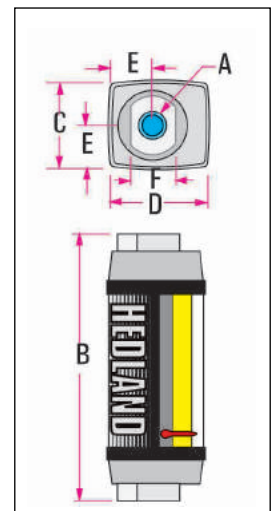

3500/6000 PSI flow meters

For phosphate ester fluids

Ordering information

Nominal port size ^①	Flow range		Pressure drop			Model number (see example below)			Material ☒			Options ◆
	gal/min	l/min	50% flow psi (bar)	100% flow psi (bar)	Reverse 100% flow psi (bar)	SAE	NPTF	BSPP	Aluminium 3500 psi	Brass 3500 psi	Stainless steel	Reverse flow
1/4" SAE 6	0.2 - 0.2	0.1 - 0.75	3.5 (.24)	4.0 (.28)		H294 ☒ - 002 - ◆	H295 ☒ - 002 - ◆	H296 ☒ - 002 - ◆	A	B	6000 psi S	Not available
	0.5 - 0.5	0.2 - 1.9	3.0 (.21)	5.0 (.35)		H294 ☒ - 005 - ◆	H295 ☒ - 005 - ◆	H296 ☒ - 005 - ◆				
	1.0 - 1.0	0.5 - 3.75	4.0 (.28)	9.0 (.62)		H294 ☒ - 010 - ◆	H295 ☒ - 010 - ◆	H296 ☒ - 010 - ◆				
	2.0 - 2.0	1.0 - 7.5	6.0 (.41)	13 (.90)		H294 ☒ - 020 - ◆	H295 ☒ - 020 - ◆	H296 ☒ - 020 - ◆				
1/2" SAE 10	0.1 - 1.0	0.5 - 3.75	2.0 (.14)	2.75 (.19)	5.2 (.36)	H694 ☒ - 001 - ◆	H695 ☒ - 001 - ◆	H696 ☒ - 001 - ◆	A	B	6000 psi S	RF
	0.2 - 2.0	1 - 7.5	2.0 (.14)	3.0 (.21)	9.6 (.66)	H694 ☒ - 002 - ◆	H695 ☒ - 002 - ◆	H696 ☒ - 002 - ◆				
	0.5 - 5.0	2 - 19	3.0 (.21)	6.0 (.41)	4.8 (.33)	H694 ☒ - 005 - ◆	H695 ☒ - 005 - ◆	H696 ☒ - 005 - ◆				
	1 - 10	5 - 38	4.0 (.28)	9.5 (.66)	23.0 (1.6)	H694 ☒ - 010 - ◆	H695 ☒ - 010 - ◆	H696 ☒ - 010 - ◆				
	1 - 15	4 - 56	6.5 (.45)	18.5 (1.3)	55.2 (3.8)	H694 ☒ - 015 - ◆	H695 ☒ - 015 - ◆	H696 ☒ - 015 - ◆				
3/4" SAE 12	0.2 - 2.0	1 - 7.5	1.0 (.07)	2.0 (.14)	2.9 (.20)	H794 ☒ - 002 - ◆	H795 ☒ - 002 - ◆	H796 ☒ - 002 - ◆	A	B	5000 psi S	RF
	0.5 - 5.0	2 - 19	2.5 (.17)	3.5 (.24)	5.3 (.37)	H794 ☒ - 005 - ◆	H795 ☒ - 005 - ◆	H796 ☒ - 005 - ◆				
	1 - 10	5 - 38	3.5 (.24)	9.0 (.62)	8.8 (.61)	H794 ☒ - 010 - ◆	H795 ☒ - 010 - ◆	H796 ☒ - 010 - ◆				
	2 - 20	10 - 76	4.0 (.28)	9.0 (.62)	18.0 (1.24)	H794 ☒ - 020 - ◆	H795 ☒ - 020 - ◆	H796 ☒ - 020 - ◆				
	3 - 30	10 - 115	7.0 (.48)	16.5 (1.1)	45.1 (3.11)	H794 ☒ - 030 - ◆	H795 ☒ - 030 - ◆	H796 ☒ - 030 - ◆				
1" SAE 16	0.2 - 2.0	1 - 7.5	1.0 (.07)	2.0 (.14)	2.9 (.20)	H764 ☒ - 002 - ◆	H765 ☒ - 002 - ◆	H766 ☒ - 002 - ◆	A	B	5000 psi S	RF
	0.5 - 5.0	2 - 19	2.5 (.17)	3.5 (.24)	5.3 (.37)	H764 ☒ - 005 - ◆	H765 ☒ - 005 - ◆	H766 ☒ - 005 - ◆				
	1 - 10	5 - 38	3.5 (.24)	9.0 (.62)	8.8 (.61)	H764 ☒ - 010 - ◆	H765 ☒ - 010 - ◆	H766 ☒ - 010 - ◆				
	2 - 20	10 - 76	4.0 (.28)	9.0 (.62)	18.0 (1.24)	H764 ☒ - 020 - ◆	H765 ☒ - 020 - ◆	H766 ☒ - 020 - ◆				
	3 - 30	10 - 115	7.0 (.48)	16.5 (1.1)	45.1 (3.11)	H764 ☒ - 030 - ◆	H765 ☒ - 030 - ◆	H766 ☒ - 030 - ◆				
	4 - 40	15 - 150	9.0 (.62)	24.0 (1.7)	87.5 (6.04)	H764 ☒ - 040 - ◆	H765 ☒ - 040 - ◆	H766 ☒ - 040 - ◆				
1 1/4" SAE 20	3 - 30	10 - 110	3.0 (.21)	4.0 (.28)	4.8 (.33)	H894 ☒ - 030 - ◆	H895 ☒ - 030 - ◆	H896 ☒ - 030 - ◆	A	B	5000 psi S	RF
	5 - 50	20 - 190	3.5 (.24)	7.0 (.48)	12.5 (.86)	H894 ☒ - 050 - ◆	H895 ☒ - 050 - ◆	H896 ☒ - 050 - ◆				
	10 - 75	40 - 280	5.0 (.35)	10.5 (.72)	31.9 (2.2)	H894 ☒ - 075 - ◆	H895 ☒ - 075 - ◆	H896 ☒ - 075 - ◆				
	10 - 100	50 - 380	6.5 (.45)	15.0 (1.0)	39.0 (2.7)	H894 ☒ - 100 - ◆	H895 ☒ - 100 - ◆	H896 ☒ - 100 - ◆				
	10 - 150	50 - 560	10.5 (.72)	27.5 (1.9)	110 (7.6)	H894 ☒ - 150 - ◆	H895 ☒ - 150 - ◆	H896 ☒ - 150 - ◆				
1 1/2" SAE 24	3 - 30	10 - 110	3.0 (.21)	4.0 (.28)	4.8 (.33)	H864 ☒ - 030 - ◆	H865 ☒ - 030 - ◆	H866 ☒ - 030 - ◆	A	B	4000 psi S	RF
	5 - 50	20 - 190	3.5 (.24)	7.0 (.48)	12.5 (.86)	H864 ☒ - 050 - ◆	H865 ☒ - 050 - ◆	H866 ☒ - 050 - ◆				
	10 - 75	40 - 280	5.0 (.35)	10.5 (.72)	31.9 (2.2)	H864 ☒ - 075 - ◆	H865 ☒ - 075 - ◆	H866 ☒ - 075 - ◆				
	10 - 100	50 - 380	6.5 (.45)	15.0 (1.0)	39.0 (2.7)	H864 ☒ - 100 - ◆	H865 ☒ - 100 - ◆	H866 ☒ - 100 - ◆				
	10 - 150	50 - 560	10.5 (.72)	27.5 (1.9)	110 (7.6)	H864 ☒ - 150 - ◆	H865 ☒ - 150 - ◆	H866 ☒ - 150 - ◆				
1 1/2" Code 62	3 - 30	10 - 110	3.0 (.21)	4.0 (.28)	4.8 (.33)	H898 ☒ - 030 - ◆			A	B	4000 psi S	RF
	5 - 50	20 - 190	3.5 (.24)	7.0 (.48)	12.5 (.86)	H898 ☒ - 050 - ◆						
	10 - 75	40 - 280	5.0 (.35)	10.5 (.72)	31.9 (2.2)	H898 ☒ - 075 - ◆						
	10 - 100	50 - 380	6.5 (.45)	15.0 (1.0)	39.0 (2.7)	H898 ☒ - 100 - ◆						
	10 - 150	50 - 560	10.5 (.72)	27.5 (1.9)	110 (7.6)	H898 ☒ - 150 - ◆						

①Fractional sizes apply to NPTF and BSPP.

Note: RF option is not available with standard brass flow meters.

Example: H 795 A - 030 - RF



3500/6000 PSI test kits

For phosphate ester fluids

- Direct reading
- Install in any position
- 360° rotatable guard/scale
- Easier-to-read linear scale
- No flow straighteners or special piping required
- Relatively insensitive to shock and vibration
- Good viscosity stability
- Temperature up to 116°C (240 °F)
- Accuracy ±2% full scale
- Repeatability ±1%
- Special scales available
- Calibrated for 1.18 S.G.



Technical data

Materials	2024 - T351 anodized aluminum body, piston and cone C360 brass body, piston and cone T303 stainless body, 2024 - T351 anodized aluminum piston and cone
Common parts:	
Spider plate: T316 SS Spring: T302 SS Fasteners: T303 SS Pressure seals: EPR End caps: Nylon ST	Retaining ring: SAE 1070/1090 carbon steel Retaining spring: SAE 1070/1090 carbon steel Indicator and internal magnet: PPS / ceramic Guard seal / bumper: EPR Scale support: 6063-T6 aluminum Guard: Nylon
Threads	SAE J1926/1, NPTF ANSI B2.2, BSPP ISO1179
Temperature range	-29 to +116 °C (-20 to +240 °F)
Pressure rating	
Aluminum / brass operating	3,500 psi/241 bar max. with a 3:1 safety factor For high cycle applications, see page conversion information
Stainless steel operating	6,000 psi/414 bar max. (5,000 psi/345 bar max. or ¼" to 1½" series) with a 3:1 safety factor. For high cycle applications, see page conversion information
Pressure drop	See ordering information table on next page, detailed differential pressure charts, page 62.
Accuracy	± 2% of full scale
Repeatability	± 1%
Pressure gauge	Glycerin dampened, 0 - 3,500 psi / 0 - 240 bar pressure range available on aluminum and brass test kits. Glycerin dampened, 0 - 6,000 psi / 0 - 400 bar pressure range available on stainless steel test kits.
Load valve	½", ¾" and 1" series - needle valve; Produce ΔP up to 3,500 psi/241 bar psiD and 6,000 psi/414 bar psiD

Dimensions

A	B	B1	C	D	E	F
Nominal port size	Length in (mm)	Length in (mm)	Width in (mm)	Depth in (mm)	Offset in (mm)	Flats in (mm)
½ (SAE 10)	6.6 (168)	10.3 (262)	2.07 (53)	2.40 (61)	1.04 (26)	1.25 (32)
¾ (SAE 12)	7.2 (183)	11.3 (287)	2.48 (63)	2.85 (72)	1.24 (32)	1.50 (38)
1 (SAE 16)	7.2 (183)	11.3 (287)	2.48 (63)	2.85 (72)	1.24 (32)	1.75 (44)

Note: Weights for all sizes can be found on page 80.
SAE and BSPP test kits include inlet adapter.

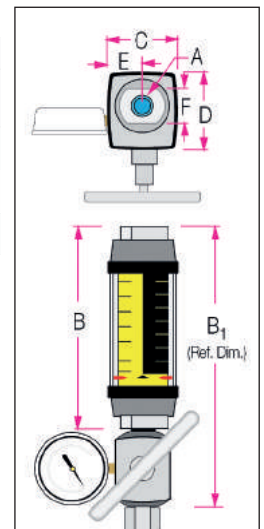

3500/6000 PSI test kits

For phosphate ester fluids

Ordering information

Nominal port size ^①	Flow range		Pressure drop			Model number (see example below)			Material ☒			Options
	gal/min	l/min	50% flow psi (bar)	100% flow psi (bar)	Reverse 100% flow psi (bar)	SAE	NPTF	BSPP	Aluminium 3500 psi	Brass 3500 psi	Stainless steel	
1/2" SAE 10	0.1 - 1.0	0.5 - 3.75	3.0 (.21)	4.75 (.33)	7.2 (.50)	H694 ☒ - 001 - TK	H695 ☒ - 001 - TK	H696 ☒ - 001 - TK	A	B	6000 psi S	RT
	0.2 - 2.0	1 - 7.5	5.0 (.34)	9.0 (.62)	15.6 (1.1)	H694 ☒ - 002 - TK	H695 ☒ - 002 - TK	H696 ☒ - 002 - TK				
	0.5 - 5.0	2 - 19	10.0 (.69)	26.0 (1.8)	24.8 (1.7)	H694 ☒ - 005 - TK	H695 ☒ - 005 - TK	H696 ☒ - 005 - TK				
	1 - 10	5 - 38	24.0 (1.7)	71.5 (4.9)	85.0 (5.9)	H694 ☒ - 010 - TK	H695 ☒ - 010 - TK	H696 ☒ - 010 - TK				
	1 - 15	4 - 56	39.0 (2.7)	155 (10.7)	210 (14.5)	H694 ☒ - 015 - TK	H695 ☒ - 015 - TK	H696 ☒ - 015 - TK				
3/4" SAE 12	0.2 - 2.0	1 - 7.5	1.5 (.10)	3.0 (.21)	3.9 (.27)	H794 ☒ - 002 - TK	H795 ☒ - 002 - TK	H796 ☒ - 002 - TK	A	B	5000 psi S	RT
	0.5 - 5.0	2 - 19	4.0 (.28)	6.5 (.45)	8.3 (.57)	H794 ☒ - 005 - TK	H795 ☒ - 005 - TK	H796 ☒ - 005 - TK				
	1 - 10	5 - 38	6.5 (.45)	16.0 (1.1)	15.8 (1.1)	H794 ☒ - 010 - TK	H795 ☒ - 010 - TK	H796 ☒ - 010 - TK				
	2 - 20	10 - 76	11.0 (.76)	26.0 (1.8)	35.0 (2.4)	H794 ☒ - 020 - TK	H795 ☒ - 020 - TK	H796 ☒ - 020 - TK				
	3 - 30	10 - 115	18.0 (1.2)	47.5 (3.3)	76.1 (5.2)	H794 ☒ - 030 - TK	H795 ☒ - 030 - TK	H796 ☒ - 030 - TK				
1" SAE 16	0.2 - 2.0	1 - 7.5	1.5 (.10)	3.0 (.21)	3.9 (.27)	H764 ☒ - 002 - TK	H765 ☒ - 002 - TK	H766 ☒ - 002 - TK	A	B	5000 psi S	RT
	0.5 - 5.0	2 - 19	4.0 (.28)	6.5 (.45)	8.3 (.57)	H764 ☒ - 005 - TK	H765 ☒ - 005 - TK	H766 ☒ - 005 - TK				
	1 - 10	5 - 38	6.5 (.45)	16.0 (1.1)	15.8 (1.1)	H764 ☒ - 010 - TK	H765 ☒ - 010 - TK	H766 ☒ - 010 - TK				
	2 - 20	10 - 76	11.0 (.76)	26.0 (1.8)	35.0 (2.4)	H764 ☒ - 020 - TK	H765 ☒ - 020 - TK	H766 ☒ - 020 - TK				
	3 - 30	10 - 115	18.0 (1.2)	47.5 (3.3)	76.1 (5.2)	H764 ☒ - 030 - TK	H765 ☒ - 030 - TK	H766 ☒ - 030 - TK				
	4 - 40	15 - 150	26.0 (1.8)	75.0 (5.2)	139 (9.6)	H764 ☒ - 040 - TK	H765 ☒ - 040 - TK	H766 ☒ - 040 - TK				
	5 - 50	20 - 190	63.5 (4.4)	114 (7.9)	230 (15.9)	H764 ☒ - 050 - TK	H765 ☒ - 050 - TK	H766 ☒ - 050 - TK				

① Fractional sizes apply to NPTF and BSPP.

Note: RT option is not available with standard brass flow meters.

Note: TK suffix represents standard test kit configuration.

For reverse flow by-pass test kit, replace TK suffix with RT suffix.

Example: H 795 A - 030 - RT



Reverse flow by-pass option:

Features a two-piece cone that responds to flow in the primary flow direction in the same manner as the standard design.

Flow in the reverse direction causes the lower cone shuttle to shift, moving it below the sharp-edged piston orifice. This shift creates a gap which allows the fluid to flow freely in the reverse direction.

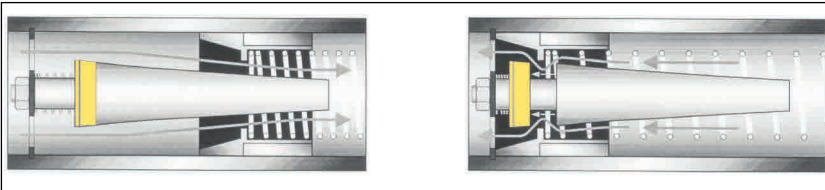

Normal flow direction

Reverse flow by-pass

3500/5000 PSI test kits

For phosphate ester fluids (1 1/4" and 1 1/2")

- Direct reading
- Install in any position
- 360° rotatable guard/scale
- Easier-to-read linear scale
- No flow straighteners or special piping required
- Relatively insensitive to shock and vibration
- Good viscosity stability
- Temperature up to 116°C (240 °F)
- Accuracy ±2% full scale
- Repeatability ±1%
- Special scales available
- Calibrated for 1.18 S.G.



Technical data

Materials	2024 - T351 anodized aluminum body, piston and cone T303 stainless body, 2024 - T351 anodized aluminum piston and cone
Common parts:	
Spider plate: T316 SS Spring: T302 SS Fasteners: T303 SS Pressure seals: EPR End caps: Nylon ST	Retaining ring: SAE 1070/1090 carbon steel Retaining spring: SAE 1070/1090 carbon steel Indicator and internal magnet: PPS / ceramic Guard seal / bumper: EPR Scale support: 6063-T6 aluminum Guard: Nylon
Threads	NPT
Temperature range	-29 to +116 °C (-20 to +240 °F)
Pressure rating	
Aluminum / brass operating	3,500 psi/241 bar max. with a 3:1 safety factor. For high cycle applications, see conversion information.
Stainless steel operating	6,000 psi/414 bar max. (5,000 psi/345 bar max. for 3/4" to 1 1/2" series, 4000 psi for code 62) with a 3:1 safety factor. For high cycle applications, see conversion information.
Pressure drop	See ordering information table on next page, detailed differential pressure charts, page 62.
Accuracy	± 2% of full scale
Repeatability	± 1%
Pressure gauge	Glycerin dampened, 0 - 3,500 psi / 0 - 240 bar pressure range available on aluminum and brass test kits. Glycerin dampened, 0 - 6,000 psi / 0 - 400 bar pressure range available on stainless steel test kits.
Load valve	Produce ΔP up to 3,500 psi/241 bar psiD and 6,000 psi/414 bar psiD

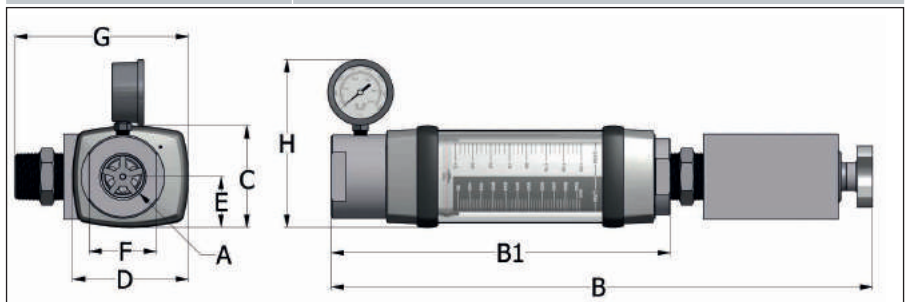

Dimensions

A	B	B1	C	D	E	F	G	H
Nominal port size	Length in (mm)	Length in (mm)	Width in (mm)	Depth in (mm)	Offset in (mm)	Flats in (mm)	Depth in (mm)	Width in (mm)
1-1/4	22.1 (561)	13.9 (353)	4.15 (105)	4.75 (121)	2.08 (53)	2.75 (70)	7.1 (180)	6.9 (175)
1-1/2	22.1 (561)	13.9 (353)	4.15 (105)	4.75 (121)	2.08 (53)	2.75 (70)	7.1 (180)	6.9 (175)

NOTE: Weights for all sizes can be found on page 80.

Pressures above 7500 psi will pop the rupture disc, allowing fluid flow to continue. This is a fail safe mechanism.

3500/5000 PSI test kits

For phosphate ester fluids

Ordering information

Nominal port size	Flow range		Pressure drop			Model number (see example below)	Material ☒		Options
	gal/min	l/min	50% Flow psi (bar)	100% Flow psi (bar)	Reverse 100% Flow psi (bar)	NPT	Aluminium 3500 psi	Stainless 5000 psi	Reverse flow
1 1/4"	3 - 30	10 - 110	3.4 (.23)	7.8 (.54)	5.6 (.39)	H TK 895 ☒ - 030	A	S	RT
	5 - 50	20 - 190	4.3 (.30)	8.8 (6.1)	14.3 (.99)	H TK 895 ☒ - 050			
	10 - 75	40 - 280	6.3 (.43)	14.3 (9.9)	35.7 (2.5)	H TK 895 ☒ - 075			
	10 - 100	50 - 380	8.3 (.57)	21.3 (1.5)	45.3 (3.1)	H TK 895 ☒ - 100			
	10 - 150	50 - 560	14.3 (.99)	41.3 (2.8)	124 (8.6)	H TK 895 ☒ - 150			
1 1/2"	3 - 30	10 - 110	3.4 (.23)	7.8 (.54)	5.6 (.39)	H TK 865 ☒ - 030	A	S	RT
	5 - 50	20 - 190	4.3 (.30)	8.8 (6.1)	14.3 (.99)	H TK 865 ☒ - 050			
	10 - 75	40 - 280	6.3 (.43)	14.3 (9.9)	35.7 (2.5)	H TK 865 ☒ - 075			
	10 - 100	50 - 380	8.3 (.57)	21.3 (1.5)	45.3 (3.1)	H TK 865 ☒ - 100			
	10 - 150	50 - 560	14.3 (.99)	41.3 (2.8)	124 (8.6)	H TK 865 ☒ - 150			

Note: TK suffix represents standard test kit configuration. For reverse flow by-pass test kit, replace TK suffix with RT suffix.



Reverse flow by-pass option: Features a two-piece cone that responds to flow in the primary flow direction in the same manner as the standard design.

Flow in the reverse direction causes the lower cone shuttle to shift, moving it below the sharp-edged piston orifice. This shift creates a gap which allows the fluid to flow freely in the reverse direction.

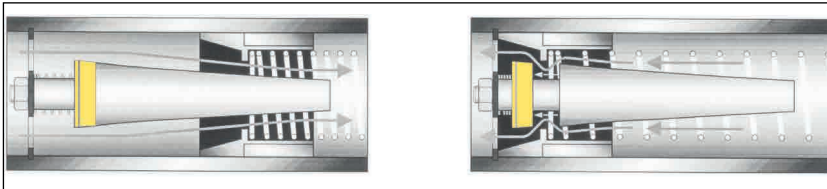

Normal flow direction

Reverse flow by-pass

3500/6000 PSI high temperature

Flow meters for phosphate ester fluids

- Direct reading
- Install in any position
- 360° rotatable guard/scale
- Easier-to-read linear scale
- No flow straighteners or special piping required
- Relatively insensitive to shock and vibration
- Good viscosity stability
- Temperature up to 205°C (500 °F)
- Accuracy ±2% full scale
- Repeatability ±1%
- Special scales available
- Calibrated for 1.18 S.G.



Technical data

Materials	2024 - T351 Anodized aluminum body, piston and cone 360 brass body, piston and cone T303 stainless body, 2024, T351 anodized aluminum piston and cone
Common parts	
Spider plate: T316 SS Spring: T302 SS Fasteners: T303 SS Seals: EPR Scale support: T316 SS Scale: Polyimide Guard: Cylindrical Pyrex® glass	Retaining ring: SAE 1070/1090 carbon steel Retaining spring: SAE 1070/1090 carbon steel Indicator: Nickel-plated carbon steel Internal magnet: Teflon® coated Alnico 8 Bumper: 2011 - T3 anodized aluminum End caps: 2011 - T3 anodized aluminum
Threads	SAE J1926/1, NPTF ANSI B2.2, BSPP ISO1179, Code 62: SAE J518
Temperature range	-29 to +205 °C (-20 to +400 °F) continuous +205 to +260 °C (+400 to +500 °F) intermittent For detailed "pressure vs. temperature" correlation information, see next page.
Pressure rating	
Aluminum / brass operating	3,500 psi/241 bar max. with a 3:1 safety factor. For high cycle applications, see page conversion information
Stainless steel operating	6,000 psi/414 bar max. (5,000 psi/345 bar max. for ¾" to 1½" series, 4000 psi for code 62) with a 3:1 safety factor. For high cycle applications, see page conversion information
Pressure drop	See ordering information table next page. For detailed differential pressure charts, see page 62.
Accuracy	±2% of full scale
Repeatability	±1%

Reverse flow by-pass option: Features a two-piece cone that responds to flow in the primary flow direction in the same manner as the standard design. Flow in the reverse direction causes the lower cone shuttle to shift, moving it below the sharp-edged piston orifice, which allows the fluid to flow freely in the reverse direction.

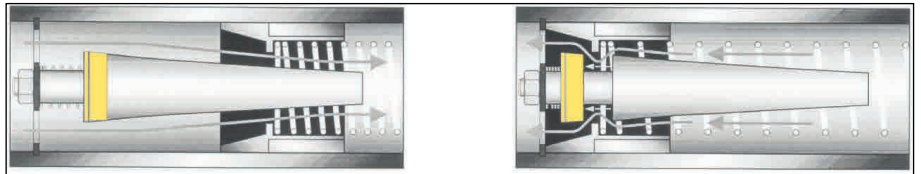

Normal flow direction

Reverse flow by-pass

Dimensions

A	B	C	D
Nominal port size	Length in (mm)	Width in (mm)	Flats in (mm)
¼ (SAE 6)	6.60 (168)	2.01 (53)	1.25 (32)
½ (SAE 10)	6.60 (168)	2.01 (53)	1.25 (32)
¾ (SAE 12)	7.20 (183)	2.48 (63)	1.50 (38)
1 (SAE 16)	7.20 (183)	2.48 (63)	1.75 (44)
1¼ (SAE 20)	12.20 (310)	4.20 (105)	2.75 (70)
1½ (SAE 24)	12.20 (310)	4.20 (105)	2.75 (70)

NOTE: Dimensions for 1½" Code 62 can be found on page 79.
Weights for all sizes can be found on page 80.

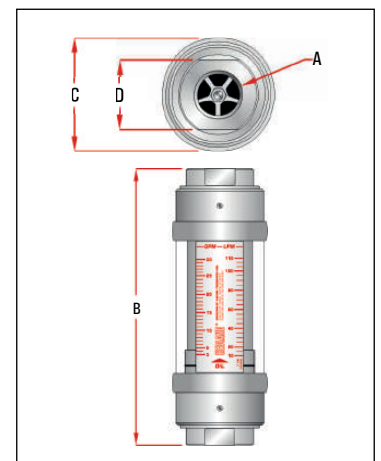

3500/6000 PSI high temperature

Flow meters for phosphate ester fluids

Ordering information

Nominal port size ^①	Flow range		Pressure drop			Model number (see example below)			Material ⌘			Options
	gal/min	l/min	50% flow psi (bar)	100% flow psi (bar)	Reverse 100% flow psi (bar)	SAE	NPTF	BSPP	Aluminium 3500 psi	Brass 3500 psi	Stainless steel	Reverse flow
¼" SAE 6	0.1 - 1.0	0.5 - 3.75	4.0 (2.8)	9.0 (6.2)		H294 ⌘ - 010 - HT	H295 ⌘ - 010 - HT	H296 ⌘ - 010 - HT	A	B	6000 psi S	Not available
	0.2 - 2.0	1.0 - 7.5	6.0 (4.1)	13 (9.0)		H294 ⌘ - 020 - HT	H295 ⌘ - 020 - HT	H296 ⌘ - 020 - HT				
½" SAE 10	0.1 - 1.0	0.5 - 3.75	2.0 (1.4)	2.75 (1.9)	5.2 (3.6)	H694 ⌘ - 001 - HT	H695 ⌘ - 001 - HT	H696 ⌘ - 001 - HT	A	B	6000 psi S	HR
	0.2 - 2.0	1 - 7.5	2.0 (1.4)	3.0 (2.1)	9.6 (6.6)	H694 ⌘ - 002 - HT	H695 ⌘ - 002 - HT	H696 ⌘ - 002 - HT				
	0.5 - 5.0	2 - 19	3.0 (2.1)	6.0 (4.1)	4.8 (3.3)	H694 ⌘ - 005 - HT	H695 ⌘ - 005 - HT	H696 ⌘ - 005 - HT				
	1 - 10	5 - 38	4.0 (2.8)	9.5 (6.6)	23.0 (1.6)	H694 ⌘ - 010 - HT	H695 ⌘ - 010 - HT	H696 ⌘ - 010 - HT				
	1 - 15	4 - 56	6.5 (4.5)	18.5 (1.3)	55.2 (3.8)	H694 ⌘ - 015 - HT	H695 ⌘ - 015 - HT	H696 ⌘ - 015 - HT				
¾" SAE 12	0.2 - 2.0	1 - 7.5	1.0 (0.7)	2.0 (1.4)	2.9 (2.0)	H794 ⌘ - 002 - HT	H795 ⌘ - 002 - HT	H796 ⌘ - 002 - HT	A	B	5000 psi S	HR
	0.5 - 5.0	2 - 19	2.5 (1.7)	3.5 (2.4)	5.3 (3.7)	H794 ⌘ - 005 - HT	H795 ⌘ - 005 - HT	H796 ⌘ - 005 - HT				
	1 - 10	5 - 38	3.5 (2.4)	9.0 (6.2)	8.8 (6.1)	H794 ⌘ - 010 - HT	H795 ⌘ - 010 - HT	H796 ⌘ - 010 - HT				
	2 - 20	10 - 76	4.0 (2.8)	9.0 (6.2)	18.0 (1.24)	H794 ⌘ - 020 - HT	H795 ⌘ - 020 - HT	H796 ⌘ - 020 - HT				
	3 - 30	10 - 115	7.0 (4.8)	16.5 (1.1)	45.1 (3.11)	H794 ⌘ - 030 - HT	H795 ⌘ - 030 - HT	H796 ⌘ - 030 - HT				
1" SAE 16	0.2 - 2.0	1 - 7.5	1.0 (0.7)	2.0 (1.4)	2.9 (2.0)	H764 ⌘ - 002 - HT	H765 ⌘ - 002 - HT	H766 ⌘ - 002 - HT	A	B	5000 psi S	HR
	0.5 - 5.0	2 - 19	2.5 (1.7)	3.5 (2.4)	5.3 (3.7)	H764 ⌘ - 005 - HT	H765 ⌘ - 005 - HT	H766 ⌘ - 005 - HT				
	1 - 10	5 - 38	3.5 (2.4)	9.0 (6.2)	8.8 (6.1)	H764 ⌘ - 010 - HT	H765 ⌘ - 010 - HT	H766 ⌘ - 010 - HT				
	2 - 20	10 - 76	4.0 (2.8)	9.0 (6.2)	18.0 (1.24)	H764 ⌘ - 020 - HT	H765 ⌘ - 020 - HT	H766 ⌘ - 020 - HT				
	3 - 30	10 - 115	7.0 (4.8)	16.5 (1.1)	45.1 (3.11)	H764 ⌘ - 030 - HT	H765 ⌘ - 030 - HT	H766 ⌘ - 030 - HT				
	4 - 40	15 - 150	9.0 (6.2)	24.0 (1.7)	87.5 (6.04)	H764 ⌘ - 040 - HT	H765 ⌘ - 040 - HT	H766 ⌘ - 040 - HT				
1¼" SAE 20	3 - 30	10 - 110	3.0 (2.1)	4.0 (2.8)	4.8 (3.3)	H894 ⌘ - 030 - HT	H895 ⌘ - 030 - HT	H896 ⌘ - 030 - HT	A	B	5000 psi S	HR
	5 - 50	20 - 190	3.5 (2.4)	7.0 (4.8)	12.5 (8.6)	H894 ⌘ - 050 - HT	H895 ⌘ - 050 - HT	H896 ⌘ - 050 - HT				
	10 - 75	40 - 280	5.0 (3.5)	10.5 (7.2)	31.9 (2.2)	H894 ⌘ - 075 - HT	H895 ⌘ - 075 - HT	H896 ⌘ - 075 - HT				
	10 - 100	50 - 380	6.5 (4.5)	15.0 (1.0)	39.0 (2.7)	H894 ⌘ - 100 - HT	H895 ⌘ - 100 - HT	H896 ⌘ - 100 - HT				
	10 - 150	50 - 560	10.5 (7.2)	27.5 (1.9)	110 (7.6)	H894 ⌘ - 150 - HT	H895 ⌘ - 150 - HT	H896 ⌘ - 150 - HT				
1½" SAE 24	3 - 30	10 - 110	3.0 (2.1)	4.0 (2.8)	4.8 (3.3)	H864 ⌘ - 030 - HT	H865 ⌘ - 030 - HT	H866 ⌘ - 030 - HT	A	B	5000 psi S	HR
	5 - 50	20 - 190	3.5 (2.4)	7.0 (4.8)	12.5 (8.6)	H864 ⌘ - 050 - HT	H865 ⌘ - 050 - HT	H866 ⌘ - 050 - HT				
	10 - 75	40 - 280	5.0 (3.5)	10.5 (7.2)	31.9 (2.2)	H864 ⌘ - 075 - HT	H865 ⌘ - 075 - HT	H866 ⌘ - 075 - HT				
	10 - 100	50 - 380	6.5 (4.5)	15.0 (1.0)	39.0 (2.7)	H864 ⌘ - 100 - HT	H865 ⌘ - 100 - HT	H866 ⌘ - 100 - HT				
	10 - 150	50 - 560	10.5 (7.2)	27.5 (1.9)	110 (7.6)	H864 ⌘ - 150 - HT	H865 ⌘ - 150 - HT	H866 ⌘ - 150 - HT				
1½" Code 62	3 - 30	10 - 110	3.0 (2.1)	4.0 (2.8)	4.8 (3.3)	H898 ⌘ - 030 - HT			A	B	4000 psi S	HR
	5 - 50	20 - 190	3.5 (2.4)	7.0 (4.8)	12.5 (8.6)	H898 ⌘ - 050 - HT						
	10 - 75	40 - 280	5.0 (3.5)	10.5 (7.2)	31.9 (2.2)	H898 ⌘ - 075 - HT						
	10 - 100	50 - 380	6.5 (4.5)	15.0 (1.0)	39.0 (2.7)	H898 ⌘ - 100 - HT						
	10 - 150	50 - 560	10.5 (7.2)	27.5 (1.9)	110 (7.6)	H898 ⌘ - 150 - HT						

① Fractional sizes apply to NPTF and BSPP.

Example: H 795 A - 030 - HR

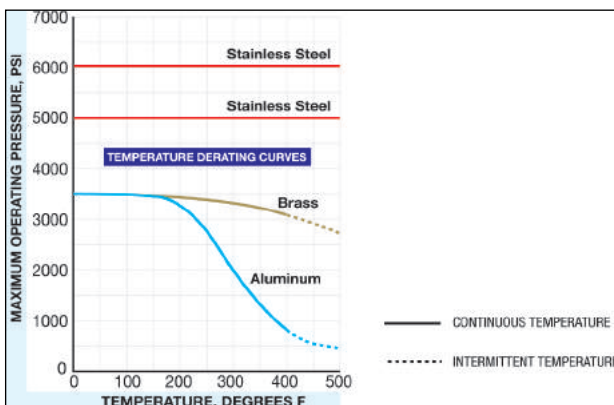

NOTE: HT suffix represents standard high temperature configuration. For reverse flow high temperature, replace HT with HR suffix.

NOTE: HR option is not available with brass flow meters.

3500/6000 PSI flow meters

For water-based fluids (water/oil emulsions)

- Direct reading
- Install in any position
- 360° rotatable guard/scale
- Easier-to-read linear scale
- No flow straighteners or special piping required
- Relatively insensitive to shock and vibration
- Good viscosity stability
- Temperature up to 116°C (240 °F)
- Accuracy ±2% full scale
- Repeatability ±1%
- Special scales available
- Calibrated for 1.0 S.G.
- For 80/20 and other water/oil emulsions

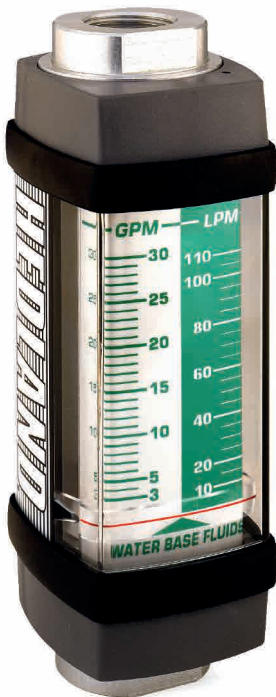

Technical data

Materials	2024 - T351 Anodized aluminum body, piston and cone C360 brass body, piston and cone ^① T303 stainless body, 2024 - T351 anodized aluminum piston and cone
Common parts	
Spider plate: T316 SS Spring: T302 SS Fasteners: T303 SS Guard seal / bumper: Buna N Guard: Polycarbonate End caps: Nylon ST	Retaining ring: T316 SS Retaining spring: T316 SS Indicator and internal magnet: PPS / ceramic Pressure seals: Viton® Scale support: 6063 - T6 aluminum
Threads	SAE J1926/1, NPTF ANSI B2.2, BSPP ISO1179, Code 61 and Code 62: SAE J518
Temperature range	-29 to +116 °C (-20 to +240 °F), for higher temp. meters, see page 32.
Pressure rating	
Aluminum / brass operating	3,500 psi/241 bar max. (800 psi/55 bar max. for 3" series) with a 3:1 safety factor For high cycle applications, see page conversion information
Stainless steel operating	6,000 psi/414 bar max. (5,000 psi/345 bar max. for ¾" to 1½" series, 4000 psi for code 62) with a 3:1 safety factor. For high cycle applications, see page conversion information
Pressure drop	See ordering information table next page. For detailed differential pressure charts, see page 62.
Accuracy	±2% of full scale, ±7% of full scale for ¼" meters
Repeatability	±1

Reverse flow by-pass option: Features a two-piece cone that responds to flow in the primary flow direction in the same manner as the standard design.

Flow in the reverse direction causes the lower cone shuttle to shift, moving it below the sharp-edged piston orifice. This shift creates a gap which allows the fluid to flow freely in the reverse direction.

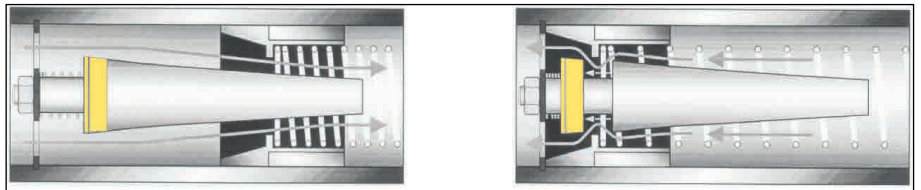

Normal flow direction

Reverse flow by-pass

Dimensions

A	B	C	D	E	F
Nominal port size	Length in (mm)	Width in (mm)	Depth in (mm)	Offset in (mm)	Flats in (mm)
¼ (SAE 6)	4.8 (122)	1.68 (43)	1.90 (48)	.84 (21)	.88 (22)
½ (SAE 10)	6.6 (168)	2.07 (53)	2.40 (61)	1.04 (26)	1.25 (32)
¾ (SAE 12)	7.2 (183)	2.48 (63)	2.85 (72)	1.24 (32)	1.50 (38)
1 (SAE 16)	7.2 (183)	2.48 (63)	2.85 (72)	1.24 (32)	1.75 (44)
1¼ (SAE 20)	12.2 (310)	4.12 (105)	4.72 (120)	2.06 (52)	2.75 (70)
1½ (SAE 24)	12.2 (310)	4.12 (105)	4.72 (120)	2.06 (52)	2.75 (70)

^①3 inch models have Celcon® piston/piston ring

Note: Dimensions for 1½" Code 62, 3" and 3" code 61 can be found on page 79. Weights for all sizes can be found on page 80.

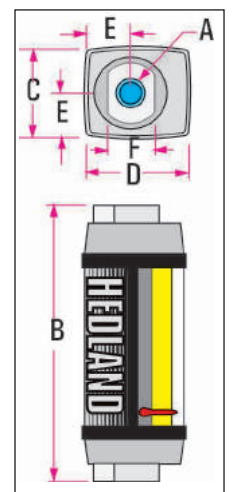

3500/6000 PSI flow meters

For water-based fluids (water/oil emulsions)

Ordering information

Nominal port size ^②	Flow range		Pressure drop			Model number (see example below)			Material			Options
	gal/min	l/min	50% flow psi (bar)	100% flow psi (bar)	Reverse 100% flow psi (bar)	SAE	NPTF	BSPP ^③	Aluminium 3500 psi	Brass 3500 psi	Stainless steel	Reverse flow
¼" SAE 6	.02 - 0.2	0.1 - 0.75	3.5 (.24)	4.0 (.28)		H212 ⌘ - 002 - ⬥	H213 ⌘ - 002 - ⬥	H214 ⌘ - 002 - ⬥	A	B	6000 psi S	Not available
	.05 - 0.5	0.2 - 1.9	3.0 (.21)	5.0 (.35)		H212 ⌘ - 005 - ⬥	H213 ⌘ - 005 - ⬥	H214 ⌘ - 005 - ⬥				
	0.1 - 1.0	0.5 - 3.75	4.0 (.28)	9.0 (.62)		H212 ⌘ - 010 - ⬥	H213 ⌘ - 010 - ⬥	H214 ⌘ - 010 - ⬥				
	0.2 - 2.0	1 - 7.5	6.0 (.41)	13 (.90)		H212 ⌘ - 020 - ⬥	H213 ⌘ - 020 - ⬥	H214 ⌘ - 020 - ⬥				
½" SAE 10	0.1 - 1.0	0.5 - 3.75	2.0 (.14)	2.75 (.19)	5.2 (.36)	H612 ⌘ - 001 - ⬥	H613 ⌘ - 001 - ⬥	H614 ⌘ - 001 - ⬥	A	B	6000 psi S	RF
	0.2 - 2.0	1 - 7.5	2.0 (.14)	3.0 (.21)	9.6 (.66)	H612 ⌘ - 002 - ⬥	H613 ⌘ - 002 - ⬥	H614 ⌘ - 002 - ⬥				
	0.5 - 5.0	2 - 19	3.0 (.21)	6.0 (.41)	4.8 (.33)	H612 ⌘ - 005 - ⬥	H613 ⌘ - 005 - ⬥	H614 ⌘ - 005 - ⬥				
	1 - 10	5 - 38	4.0 (.28)	9.5 (.66)	23.0 (1.6)	H612 ⌘ - 010 - ⬥	H613 ⌘ - 010 - ⬥	H614 ⌘ - 010 - ⬥				
¾" SAE 12	0.2 - 2.0	1 - 7.5	1.0 (.07)	2.0 (.14)	2.9 (.20)	H712 ⌘ - 002 - ⬥	H713 ⌘ - 002 - ⬥	H714 ⌘ - 002 - ⬥	A	B	5000 psi S	RF
	0.5 - 5.0	2 - 19	2.5 (.17)	3.5 (.24)	5.3 (.37)	H712 ⌘ - 005 - ⬥	H713 ⌘ - 005 - ⬥	H714 ⌘ - 005 - ⬥				
	1 - 10	5 - 38	3.5 (.24)	9.0 (.62)	8.8 (.61)	H712 ⌘ - 010 - ⬥	H713 ⌘ - 010 - ⬥	H714 ⌘ - 010 - ⬥				
	2 - 20	10 - 76	4.0 (.28)	9.0 (.62)	18.0 (1.24)	H712 ⌘ - 020 - ⬥	H713 ⌘ - 020 - ⬥	H714 ⌘ - 020 - ⬥				
1" SAE 16	0.2 - 2.0	1 - 7.5	1.0 (.07)	2.0 (.14)	2.9 (.20)	H782 ⌘ - 002 - ⬥	H783 ⌘ - 002 - ⬥	H784 ⌘ - 002 - ⬥	A	B	5000 psi S	RF
	0.5 - 5.0	2 - 19	2.5 (.17)	3.5 (.24)	5.3 (.37)	H782 ⌘ - 005 - ⬥	H783 ⌘ - 005 - ⬥	H784 ⌘ - 005 - ⬥				
	1 - 10	5 - 38	3.5 (.24)	9.0 (.62)	8.8 (.61)	H782 ⌘ - 010 - ⬥	H783 ⌘ - 010 - ⬥	H784 ⌘ - 010 - ⬥				
	2 - 20	10 - 76	4.0 (.28)	9.0 (.62)	18.0 (1.24)	H782 ⌘ - 020 - ⬥	H783 ⌘ - 020 - ⬥	H784 ⌘ - 020 - ⬥				
1¼" SAE 20	3 - 30	10 - 110	7.0 (.48)	16.5 (1.1)	45.1 (3.11)	H782 ⌘ - 030 - ⬥	H783 ⌘ - 030 - ⬥	H784 ⌘ - 030 - ⬥	A	B	5000 psi S	RF
	5 - 50	20 - 190	3.0 (.21)	4.0 (.28)	4.8 (.33)	H812 ⌘ - 030 - ⬥	H813 ⌘ - 030 - ⬥	H814 ⌘ - 030 - ⬥				
	10 - 75	40 - 280	5.0 (.35)	10.5 (.72)	31.9 (2.2)	H812 ⌘ - 075 - ⬥	H813 ⌘ - 075 - ⬥	H814 ⌘ - 075 - ⬥				
	10 - 100	50 - 380	6.5 (.45)	15.0 (1.0)	39.0 (2.7)	H812 ⌘ - 100 - ⬥	H813 ⌘ - 100 - ⬥	H814 ⌘ - 100 - ⬥				
1½" SAE 24	10 - 150	50 - 560	10.5 (.72)	27.5 (1.9)	110 (7.6)	H812 ⌘ - 150 - ⬥	H813 ⌘ - 150 - ⬥	H814 ⌘ - 150 - ⬥	A	B	5000 psi S	RF
	3 - 30	10 - 110	3.0 (.21)	4.0 (.28)	4.8 (.33)	H882 ⌘ - 030 - ⬥	H883 ⌘ - 030 - ⬥	H884 ⌘ - 030 - ⬥				
	5 - 50	20 - 190	3.5 (.24)	7.0 (.48)	12.5 (.86)	H882 ⌘ - 050 - ⬥	H883 ⌘ - 050 - ⬥	H884 ⌘ - 050 - ⬥				
	10 - 75	40 - 280	5.0 (.35)	10.5 (.72)	31.9 (2.2)	H882 ⌘ - 075 - ⬥	H883 ⌘ - 075 - ⬥	H884 ⌘ - 075 - ⬥				
1½" Code 62	10 - 100	50 - 380	6.5 (.45)	15.0 (1.0)	39.0 (2.7)	H882 ⌘ - 100 - ⬥	H883 ⌘ - 100 - ⬥	H884 ⌘ - 100 - ⬥	A	B	4000 psi S	RF
	10 - 150	50 - 560	10.5 (.72)	27.5 (1.9)	110 (7.6)	H882 ⌘ - 150 - ⬥	H883 ⌘ - 150 - ⬥	H884 ⌘ - 150 - ⬥				
	3 - 30	10 - 110	3.0 (.21)	4.0 (.28)	4.8 (.33)	H818 ⌘ - 030 - ⬥						
	5 - 50	20 - 190	3.5 (.24)	7.0 (.48)	12.5 (.86)	H818 ⌘ - 050 - ⬥						
3"	20 - 180	100 - 650	11 (.76)	17 (1.1)		Not available	H913 ⌘ - 180 - ⬥	H914 ⌘ - 180 - ⬥	A	B	800 psi	Not available
	20 - 275	100 - 1000	11 (.76)	18 (1.2)			H913 ⌘ - 275 - ⬥	H914 ⌘ - 275 - ⬥				
3" Code 61	10 - 200	50 - 750	11 (.76)	17 (1.1)		H919 ⌘ - 180 - ⬥			A	B	800 psi	Not available
	20 - 300	100 - 1100	11 (.76)	18 (1.2)		H919 ⌘ - 275 - ⬥						

② Fractional sizes apply to NPTF and BSPP.

③ 3 inch models have BSPT (BS21) threads

Note: RF option is not available with standard brass flow meters.



Caution: For emulsions with less than 20% oil, factory recommends the brass body meter.

Example: H 713 A - 030 - RF

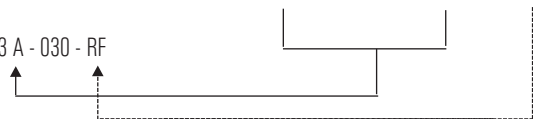

3500/6000 PSI test kits

For water-based fluids (water/oil emulsions)

- Direct reading
- Install in any position
- 360° rotatable guard/scale
- Easier-to-read linear scale
- No flow straighteners or special piping required
- Relatively insensitive to shock and vibration
- Good viscosity stability
- Temperature up to 116°C (240 °F)
- Accuracy ±2% full scale
- Repeatability ±1%
- Special scales available
- Calibrated for 1.0 S.G.
- For 80/20 and other water/oil emulsions



Technical data

Materials	2024 - T351 Anodized aluminum body, piston and cone C360 Brass body, piston and cone T303 stainless body, 2024 - T351 anodized aluminum piston and cone
Common parts	
Spider plate: T316 SS Spring: T302 SS Fasteners: T303 SS Guard seal / bumper: Buna N Scale support: 6063 - T6 aluminum End caps: Nylon ST	Retaining ring: T316 SS Retaining spring: T316 SS Indicator and internal magnet: PPS / ceramic Pressure seals: Viton® Guard: Polycarbonate
Threads	SAE J1926/1, NPTF ANSI B2.2, BSPP ISO1179
Temperature range	-29 to +116 °C (-20 to +240 °F)
Pressure rating	
Aluminum / brass operating	3,500 psi/241 bar max. with a 3:1 safety factor. For high cycle applications, see page conversion information.
Stainless steel operating	6,000 psi/414 bar max. (5,000 psi/345 bar max. for 3/4" series) with a 3:1 safety factor. For high cycle applications, see page conversion information.
Pressure drop	See ordering information table next page. For detailed differential pressure charts, see page 62.
Accuracy	±2% of full scale
Repeatability	±1%
Pressure gauge	Glycerin dampened, 0 - 3,500 psi / 0 - 240 bar pressure range available on aluminum and brass test kits. Glycerin dampened, 0 - 6,000 psi / 0 - 400 bar pressure range available on stainless steel test kits.
Load valve	½", ¾" and 1" series - needle valve; Produce ΔP up to 3,500 psi/241 bar psiD and 6,000 psi/414 bar psiD.

Dimensions

	A	B	B1	C	D	E	F
Nominal port size	Length in (mm)	Length in (mm)	Length in (mm)	Width in (mm)	Depth in (mm)	Offset in (mm)	Flats in (mm)
½ (SAE 10)	6.6 (168)	10.3 (262)	2.07 (53)	2.40 (61)	1.04 (26)	1.25 (32)	
¾ (SAE 12)	7.2 (183)	11.3 (287)	2.48 (63)	2.85 (72)	1.24 (32)	1.50 (38)	
1 (SAE 16)	7.2 (183)	11.3 (287)	2.48 (63)	2.85 (72)	1.24 (32)	1.75 (44)	

Note: Weights for all sizes can be found on page 80.

SAE and BSPP test kits include inlet adapter.

Pressure above 7500 psi will pop the rupture disc, allowing fluid flow to continue. This is a fail safe mechanism.

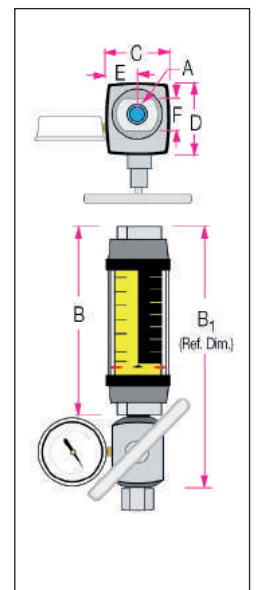

3500/6000 PSI test kits

For water-based fluids (water/oil emulsions)

Ordering information

Nominal port size ^①	Flow range		Pressure drop			Model number (see example below)			Material ☒			Options
	gal/min	l/min	50% flow psi (bar)	100% flow psi (bar)	Reverse 100% flow psi (bar)	SAE	NPTF	BSPP	Aluminium 3500 psi	Brass 3500 psi	Stainless steel	Reverse flow
½" SAE 10	0.1 - 1.0	0.5 - 3.75	3.0 (.21)	4.75 (.33)	7.2 (.50)	H612 ☒ - 001 - TK	H613 ☒ - 001 - TK	H614 ☒ - 001 - TK	A	B	6000 psi S	RT
	0.2 - 2.0	1 - 7.5	5.0 (.34)	9.0 (.62)	15.6 (1.1)	H612 ☒ - 002 - TK	H613 ☒ - 002 - TK	H614 ☒ - 002 - TK				
	0.5 - 5.0	2 - 19	10.0 (.69)	26.0 (1.8)	24.8 (1.7)	H612 ☒ - 005 - TK	H613 ☒ - 005 - TK	H614 ☒ - 005 - TK				
	1 - 10	5 - 38	24.0 (1.7)	71.5 (4.9)	85.0 (5.9)	H612 ☒ - 010 - TK	H613 ☒ - 010 - TK	H614 ☒ - 010 - TK				
	1 - 15	4 - 56	39.0 (2.7)	155 (10.7)	210 (14.5)	H612 ☒ - 015 - TK	H613 ☒ - 015 - TK	H614 ☒ - 015 - TK				
¾" SAE 12	0.2 - 2.0	1 - 7.5	1.5 (1.0)	3.0 (.21)	3.9 (.27)	H712 ☒ - 002 - TK	H713 ☒ - 002 - TK	H714 ☒ - 002 - TK	A	B	5000 psi S	RT
	0.5 - 5.0	2 - 19	4.0 (.28)	6.5 (.45)	8.3 (.57)	H712 ☒ - 005 - TK	H713 ☒ - 005 - TK	H714 ☒ - 005 - TK				
	1 - 10	5 - 38	6.5 (.45)	16.0 (1.1)	15.8 (1.1)	H712 ☒ - 010 - TK	H713 ☒ - 010 - TK	H714 ☒ - 010 - TK				
	2 - 20	10 - 76	11.0 (.76)	26.0 (1.8)	35.0 (2.4)	H712 ☒ - 020 - TK	H713 ☒ - 020 - TK	H714 ☒ - 020 - TK				
	3 - 30	10 - 115	18.0 (1.2)	47.5 (3.3)	76.1 (5.2)	H712 ☒ - 030 - TK	H713 ☒ - 030 - TK	H714 ☒ - 030 - TK				
1" SAE 16	0.2 - 2.0	1 - 7.5	1.5 (1.0)	3.0 (.21)	3.9 (.27)	H782 ☒ - 002 - TK	H783 ☒ - 002 - TK	H784 ☒ - 002 - TK	A	B	5000 psi S	RT
	0.5 - 5.0	2 - 19	4.0 (.28)	6.5 (.45)	8.3 (.57)	H782 ☒ - 005 - TK	H783 ☒ - 005 - TK	H784 ☒ - 005 - TK				
	1 - 10	5 - 38	6.5 (.45)	16.0 (1.1)	15.8 (1.1)	H782 ☒ - 010 - TK	H783 ☒ - 010 - TK	H784 ☒ - 010 - TK				
	2 - 20	10 - 76	11.0 (.76)	26.0 (1.8)	35.0 (2.4)	H782 ☒ - 020 - TK	H783 ☒ - 020 - TK	H784 ☒ - 020 - TK				
	3 - 30	10 - 115	18.0 (1.2)	47.5 (3.3)	76.1 (5.2)	H782 ☒ - 030 - TK	H783 ☒ - 030 - TK	H784 ☒ - 030 - TK				

① Fractional sizes apply to NPTF and BSPP.

Example: H 713 A - 030 - RT

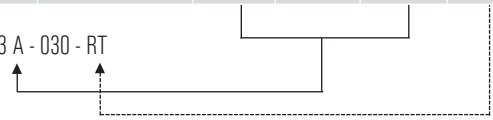

Note: TK suffix represents standard test kit configuration. For reverse flow by-pass test kit, replace TK suffix with RT suffix.

Note: RT option is not available with standard brass flow meters.



Caution: For emulsions with less than 20% oil, factory recommends the brass body meter.

Reverse flow by-pass option: Features a two-piece cone that responds to flow in the primary flow direction in the same manner as the standard design.

Flow in the reverse direction causes the lower cone shuttle to shift, moving it below the sharp-edged piston orifice. This shift creates a gap which allows the fluid to flow freely in the reverse direction.

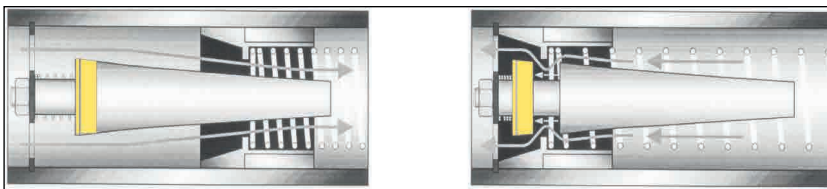

Normal flow direction

Reverse flow by-pass

3500/5000 PSI test kits

For water-based fluids (water/oil emulsions) (1 1/4" and 1 1/2")

- Direct reading
- Install in any position
- 360° rotatable guard/scale
- Easier-to-read linear scale
- No flow straighteners or special piping required
- Relatively insensitive to shock and vibration
- Good viscosity stability
- Temperature up to 116°C (240 °F)
- Accuracy ±2% full scale
- Repeatability ±1%
- Special scales available
- Calibrated for 1.0 S.G.
- For 80/20 and other water/oil emulsions

Technical data

Materials	2024 - T351 anodized aluminum body, piston and cone T303 stainless body, 2024 - T351 anodized aluminum piston and cone
Common parts	
Spider plate: T316 SS Spring: T302 SS Fasteners: T303 SS Guard seal / bumper: Buna N Scale support: 6063 - T6 aluminum End caps: Nylon ST	Retaining ring: T316 SS Retaining spring: T316 SS Indicator and internal magnet: PPS / ceramic Pressure seals: Viton® Guard: Polycarbonate
Threads	NPT
Temperature range	-29 to +116 °C (-20 to +240 °F)
Pressure rating	
Aluminum / brass operating	3,500 psi/241 bar max. with a 3:1 safety factor. For high cycle applications, see conversion information.
Stainless steel operating	6,000 psi/414 bar max. (5,000 psi/345 bar max. for 3/4" to 1 1/2" series, 4000psi for code 62) with a 3:1 safety factor. For high cycle applications, see conversion information.
Pressure drop	See ordering information table next page. For detailed differential pressure charts, see page 62.
Accuracy	±2% of full scale
Repeatability	±1%
Pressure gauge	Glycerin dampened, 0 - 3,500 psi / 0 - 240 bar pressure range available on aluminum and brass test kits. Glycerin dampened, 0 - 6,000 psi / 0 - 400 bar pressure range available on stainless steel test kits.
Load valve	Produce ΔP up to 3,500 psi/241 bar psiID and 6,000 psi/414 bar psiID.

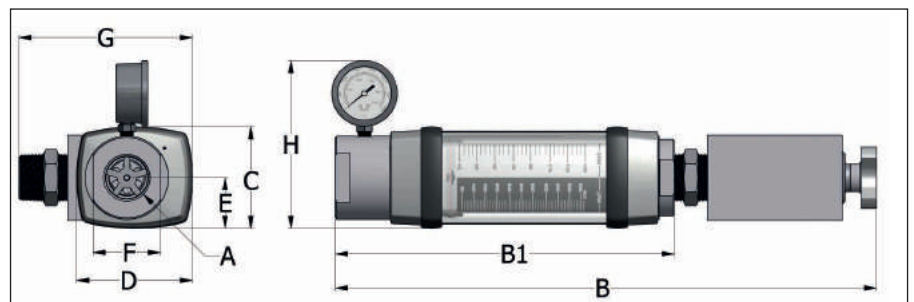

Dimensions

A	B	B1	C	D	E	F	G	H
Nominal port size	Length in (mm)	Length in (mm)	Width in (mm)	Depth in (mm)	Offset in (mm)	Flats in (mm)	Depth in (mm)	Width in (mm)
1-1/4	22.1 (561)	13.9 (353)	4.15 (105)	4.75 (121)	2.08 (53)	2.75 (70)	7.1 (180)	6.9 (175)
1-1/2	22.1 (561)	13.9 (353)	4.15 (105)	4.75 (121)	2.08 (53)	2.75 (70)	7.1 (180)	6.9 (175)

Note: Weights for all sizes can be found on page 80.

3500/5000 PSI test kits

For water-based fluids (water/oil emulsions) (1 1/4" and 1 1/2")

Ordering information

Nominal port size	Flow range		Pressure drop			Model number (see example below)	Material		Options
	gal/min	l/min	50% flow psi (bar)	100% flow psi (bar)	Reverse 100% flow psi (bar)	NPT	Aluminum 3500 psi	Stainless 5000 psi	Reverse flow
1 1/4"	3 - 30	10 - 110	3.4 (.23)	7.8 (.54)	5.6 (.39)	H TK 813 * - 030	A	S	RT
	5 - 50	20 - 190	4.3 (.30)	8.8 (6.1)	14.3 (.99)	H TK 813 * - 050			
	10 - 75	40 - 280	6.3 (.43)	14.3 (9.9)	35.7 (2.5)	H TK 813 * - 075			
	10 - 100	50 - 380	8.3 (.57)	21.3 (1.5)	45.3 (3.1)	H TK 813 * - 100			
	10 - 150	50 - 560	14.3 (1.99)	41.3 (2.8)	124 (8.6)	H TK 813 * - 150			
1 1/2"	3 - 30	10 - 110	3.4 (.23)	7.8 (.54)	5.6 (.39)	H TK 883 * - 030	A	S	RT
	5 - 50	20 - 190	4.3 (.30)	8.8 (6.1)	14.3 (.99)	H TK 883 * - 050			
	10 - 75	40 - 280	6.3 (.43)	14.3 (9.9)	35.7 (2.5)	H TK 883 * - 075			
	10 - 100	50 - 380	8.3 (.57)	21.3 (1.5)	45.3 (3.1)	H TK 883 * - 100			
	10 - 150	50 - 560	14.3 (1.99)	41.3 (2.8)	124 (8.6)	H TK 883 * - 150			

Note: TK suffix represents standard test kit configuration. For reverse flow by-pass test kit, replace TK suffix with RT suffix.

(Example) H RT 813 A - 030

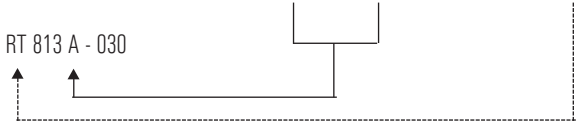

Caution: For emulsions with less than 20% oil, factory recommends the brass body meter.

Reverse flow by-pass option: Features a two-piece cone that responds to flow in the primary flow direction in the same manner as the standard design.

Flow in the reverse direction causes the lower cone shuttle to shift, moving it below the sharp-edged piston orifice. This shift creates a gap which allows the fluid to flow freely in the reverse direction.

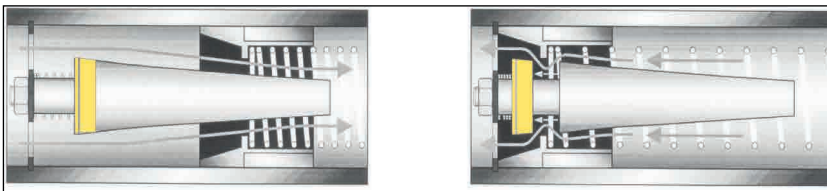

Normal flow direction

Reverse flow by-pass

3500/6000 PSI high temperature

Flow meters for water-based fluids (water/oil emulsions)

- Direct reading
- Install in any position
- 360° rotatable guard/scale
- Easier-to-read linear scale
- No flow straighteners or special piping required
- Relatively insensitive to shock and vibration
- Good viscosity stability
- Temperature up to 260°C (500 °F)
- Accuracy ±2% full scale
- Repeatability ±1%
- Special scales available
- Calibrated for 1.0 S.G.
- For 80/20 and other water/oil emulsions

Technical data

Materials	2024 - T351 anodized aluminum body, piston and cone C360 brass body, piston and cone T303 stainless body, 2024 - T351 anodized aluminum piston and cone
Common parts	
Spider plate: T316 SS Spring: T302 SS Fasteners: T303 SS Seals: Viton® Scale support: T316 SS Guard: Cylindrical Pyrex® glass Scale: Polymide	Retaining ring: T316 SS Retaining spring: T316 SS Indicator: Nickel-plated carbon steel Internal magnet: Teflon® coated Alnico 8 Bumper: 2011 - T3 anodized aluminum End caps: 2011 - T3 anodized aluminum
Threads	SAE J1926/1, NPTF ANSI B2.2, BSPP ISO1179, Code 62: SAE J518
Temperature range	-29 to +205 °C (-20 to +400 °F) continuous +205 to +260 °C (+400 to +500 °F) intermittent Detailed "Pressure vs. temperature" correlation information, see next page.
Pressure rating	
Aluminum / brass operating	3,500 psi/241 bar max. with a 3:1 safety factor. For high cycle applications, see page conversion information.
Stainless steel operating	6,000 psi/414 bar max. (5,000 psi/345 bar max. for ¾" to 1½" series, 4000 psi for code 62) with a 3:1 safety factor. For high cycle applications, see page conversion information.
Pressure drop	See ordering information table, next page For detailed differential pressure charts, see page 62.
Accuracy	±2% of full scale
Repeatability	±1%



Reverse flow by-pass option: Features a two-piece cone that responds to flow in the primary flow direction in the same manner as the standard design.

Flow in the reverse direction causes the lower cone shuttle to shift, moving it below the sharp-edged piston orifice, which allows the fluid to flow freely in the reverse direction.

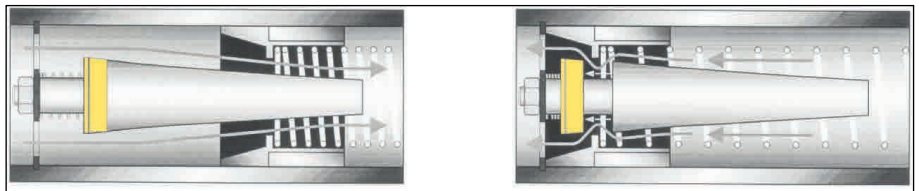

Normal flow direction

Reverse flow by-pass

Dimensions

A	B	C	D
Nominal port size	Length in (mm)	Width in (mm)	Flats in (mm)
¼ (SAE 6)	6.60 (168)	2.01 (53)	1.25 (32)
½ (SAE 10)	6.60 (168)	2.01 (53)	1.25 (32)
¾ (SAE 12)	7.20 (183)	2.48 (63)	1.50 (38)
1 (SAE 16)	7.20 (183)	2.48 (63)	1.75 (44)
1¼ (SAE 20)	12.20 (310)	4.20 (105)	2.75 (70)
1½ (SAE 24)	12.20 (310)	4.20 (105)	2.75 (70)

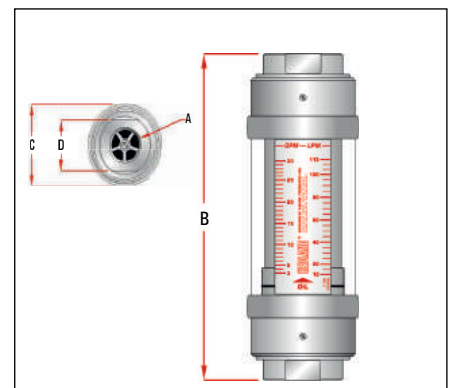

Note: Dimensions for 1½" Code 62 can be found on page 79. Weights for all sizes can be found on page 80.

3500/6000 PSI high temperature

Flow meters for water-based fluids (water/oil emulsions)

Ordering information

Nominal port size ^①	Flow range		Pressure drop			Model number (see example below)			Material			Options
	gal/min	l/min	50% flow psi (bar)	100% flow psi (bar)	Reverse 100% flow psi (bar)	SAE	NPTF	BSPB	Aluminium 3500 psi	Brass 3500 psi	Stainless steel	Reverse flow
¼" SAE 6	0.1 - 1.0	0.5 - 3.75	4.0 (.28)	9.0 (.62)		H212 ☒ - 010 - HT	H213 ☒ - 010 - HT	H214 ☒ - 010 - HT	A	B	6000 psi S	Not available
	0.2 - 2.0	1.0 - 7.5	6.0 (.41)	13 (.90)		H212 ☒ - 020 - HT	H213 ☒ - 020 - HT	H214 ☒ - 020 - HT				
½" SAE 10	0.1 - 1.0	0.5 - 3.75	2.0 (.14)	2.75 (.19)	5.2 (.36)	H612 ☒ - 001 - HT	H613 ☒ - 001 - HT	H614 ☒ - 001 - HT	A	B	6000 psi S	HR
	0.2 - 2.0	1 - 7.5	2.0 (.14)	3.0 (.21)	9.6 (.66)	H612 ☒ - 002 - HT	H613 ☒ - 002 - HT	H614 ☒ - 002 - HT				
	0.5 - 5.0	2 - 19	3.0 (.21)	6.0 (.41)	4.8 (.33)	H612 ☒ - 005 - HT	H613 ☒ - 005 - HT	H614 ☒ - 005 - HT				
	1 - 10	5 - 38	4.0 (.28)	9.5 (.66)	23.0 (1.6)	H612 ☒ - 010 - HT	H613 ☒ - 010 - HT	H614 ☒ - 010 - HT				
	1 - 15	4 - 56	6.5 (.45)	18.5 (1.3)	55.2 (3.8)	H612 ☒ - 015 - HT	H613 ☒ - 015 - HT	H614 ☒ - 015 - HT				
¾" SAE 12	0.2 - 2.0	1 - 7.5	1.0 (.07)	2.0 (.14)	2.9 (.20)	H712 ☒ - 002 - HT	H713 ☒ - 002 - HT	H714 ☒ - 002 - HT	A	B	5000 psi S	HR
	0.5 - 5.0	2 - 19	2.5 (.17)	3.5 (.24)	5.3 (.37)	H712 ☒ - 005 - HT	H713 ☒ - 005 - HT	H714 ☒ - 005 - HT				
	1 - 10	5 - 38	3.5 (.24)	9.0 (.62)	8.8 (.61)	H712 ☒ - 010 - HT	H713 ☒ - 010 - HT	H714 ☒ - 010 - HT				
	2 - 20	10 - 76	4.0 (.28)	9.0 (.62)	18.0 (1.24)	H712 ☒ - 020 - HT	H713 ☒ - 020 - HT	H714 ☒ - 020 - HT				
	3 - 30	10 - 115	7.0 (.48)	16.5 (1.1)	45.1 (3.11)	H712 ☒ - 030 - HT	H713 ☒ - 030 - HT	H714 ☒ - 030 - HT				
1" SAE 16	0.2 - 2.0	1 - 7.5	1.0 (.07)	2.0 (.14)	2.9 (.20)	H782 ☒ - 002 - HT	H783 ☒ - 002 - HT	H784 ☒ - 002 - HT	A	B	5000 psi S	HR
	0.5 - 5.0	2 - 19	2.5 (.17)	3.5 (.24)	5.3 (.37)	H782 ☒ - 005 - HT	H783 ☒ - 005 - HT	H784 ☒ - 005 - HT				
	1 - 10	5 - 38	3.5 (.24)	9.0 (.62)	8.8 (.61)	H782 ☒ - 010 - HT	H783 ☒ - 010 - HT	H784 ☒ - 010 - HT				
	2 - 20	10 - 76	4.0 (.28)	9.0 (.62)	18.0 (1.24)	H782 ☒ - 020 - HT	H783 ☒ - 020 - HT	H784 ☒ - 020 - HT				
	3 - 30	10 - 115	7.0 (.48)	16.5 (1.1)	45.1 (3.11)	H782 ☒ - 030 - HT	H783 ☒ - 030 - HT	H784 ☒ - 030 - HT				
	4 - 40	15 - 150	9.0 (.62)	24.0 (1.7)	87.5 (6.04)	H782 ☒ - 040 - HT	H783 ☒ - 040 - HT	H784 ☒ - 040 - HT				
1¼" SAE 20	3 - 30	10 - 110	3.0 (.21)	4.0 (.28)	4.8 (.33)	H812 ☒ - 030 - HT	H813 ☒ - 030 - HT	H814 ☒ - 030 - HT	A	B	5000 psi S	HR
	5 - 50	20 - 190	3.5 (.24)	7.0 (.48)	12.5 (.86)	H812 ☒ - 050 - HT	H813 ☒ - 050 - HT	H814 ☒ - 050 - HT				
	10 - 75	40 - 280	5.0 (.35)	10.5 (.72)	31.9 (2.2)	H812 ☒ - 075 - HT	H813 ☒ - 075 - HT	H814 ☒ - 075 - HT				
	10 - 100	50 - 380	6.5 (.45)	15.0 (1.0)	39.0 (2.7)	H812 ☒ - 100 - HT	H813 ☒ - 100 - HT	H814 ☒ - 100 - HT				
	10 - 150	50 - 560	10.5 (.72)	27.5 (1.9)	110 (7.6)	H812 ☒ - 150 - HT	H813 ☒ - 150 - HT	H814 ☒ - 150 - HT				
1½" SAE 24	3 - 30	10 - 110	3.0 (.21)	4.0 (.28)	4.8 (.33)	H882 ☒ - 030 - HT	H883 ☒ - 030 - HT	H884 ☒ - 030 - HT	A	B	5000 psi S	HR
	5 - 50	20 - 190	3.5 (.24)	7.0 (.48)	12.5 (.86)	H882 ☒ - 050 - HT	H883 ☒ - 050 - HT	H884 ☒ - 050 - HT				
	10 - 75	40 - 280	5.0 (.35)	10.5 (.72)	31.9 (2.2)	H882 ☒ - 075 - HT	H883 ☒ - 075 - HT	H884 ☒ - 075 - HT				
	10 - 100	50 - 380	6.5 (.45)	15.0 (1.0)	39.0 (2.7)	H882 ☒ - 100 - HT	H883 ☒ - 100 - HT	H884 ☒ - 100 - HT				
	10 - 150	50 - 560	10.5 (.72)	27.5 (1.9)	110 (7.6)	H882 ☒ - 150 - HT	H883 ☒ - 150 - HT	H884 ☒ - 150 - HT				
1½" Code 62	3 - 30	10 - 110	3.0 (.21)	4.0 (.28)	4.8 (.33)	H818 ☒ - 030 - HT			A	B	4000 psi S	HR
	5 - 50	20 - 190	3.5 (.24)	7.0 (.48)	12.5 (.86)	H818 ☒ - 050 - HT						
	10 - 75	40 - 280	5.0 (.35)	10.5 (.72)	31.9 (2.2)	H818 ☒ - 075 - HT						
	10 - 100	50 - 380	6.5 (.45)	15.0 (1.0)	39.0 (2.7)	H818 ☒ - 100 - HT						
	10 - 150	50 - 560	10.5 (.72)	27.5 (1.9)	110 (7.6)	H818 ☒ - 150 - HT						

① Fractional sizes apply to NPTF and BSPB.

Note: HT suffix represents standard high temperature configuration. For reverse flow high temperature, replace HT with HR suffix.

Note: HR option is not available with brass flow meters.



Caution: For emulsions with less than 20% oil, factory recommends the Brass body meter.

Example: H 713 A - 030 - HR

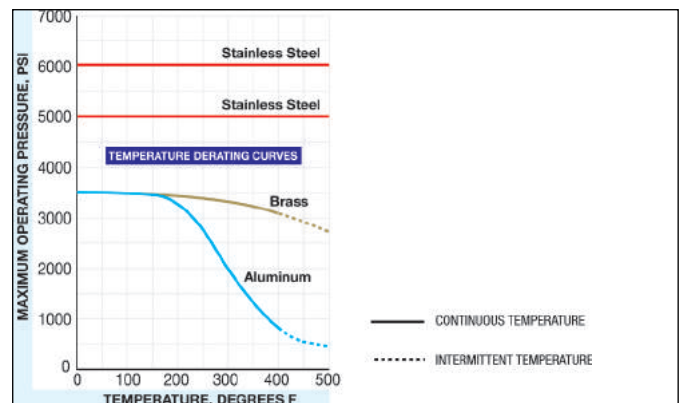
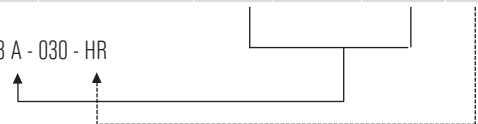

3500/6000 PSI flow meters

For water and other liquids

- Direct reading
- Install in any position
- 360° rotatable guard/scale
- Easier-to-read linear scale
- No flow straighteners or special piping required
- Relatively insensitive to shock and vibration
- Good viscosity stability
- Temperature up to 116°C (240 °F)
- Accuracy ±2% full scale
- Repeatability ±1%
- Special scales available
- Calibrated for 1.0 S.G.



Technical data

Materials	C360 Brass body, piston and cone ^① T303 Stainless body, C360 brass piston and cone
Common parts	
Spider plate: T316 SS Spring: T302 SS Fasteners: T303 SS Guard seal / bumper: Buna N Guard: Polycarbonate End caps: Nylon ST	Retaining ring: T316 SS Retaining spring: T316 SS Indicator and internal magnet: PPS / ceramic Pressure seals: Viton [®] Scale support: 6063 - T6 aluminum
Threads	SAE J1926/1, NPTF ANSI B2.2, BSPP ISO1179
Temperature range	-29 to +116 °C (-20 to +240 °F) For higher temp. meters, see page 36.
Pressure rating	
Brass operating	3,500 psi/241 bar max. (800 psi/55 bar max. for 3" series) with a 3:1 safety factor. For high cycle applications, see page conversion information.
Stainless steel operating	6,000 psi/414 bar max. (5,000 psi/345 bar max. for ¼" to 1½" series) with a 3:1 safety factor. For high cycle applications, see page conversion information.
Pressure drop	See ordering information table next page. For detailed differential pressure charts, see page 62.
Accuracy	±2% of full scale, ±7% of full scale for ¼" meters
Repeatability	±1%

Dimensions

A	B	C	D	E	F
Nominal port size	Length in (mm)	Width in (mm)	Depth in (mm)	Offset in (mm)	Flats in (mm)
¼ (SAE 6)	4.8 (122)	1.68 (43)	1.90 (48)	.84 (21)	.88 (22)
½ (SAE 10)	6.6 (168)	2.07 (53)	2.40 (61)	1.04 (26)	1.25 (32)
¾ (SAE 12)	7.2 (183)	2.48 (63)	2.85 (72)	1.24 (32)	1.50 (38)
1 (SAE 16)	7.2 (183)	2.48 (63)	2.85 (72)	1.24 (32)	1.75 (44)
1¼ (SAE 20)	12.2 (310)	4.12 (105)	4.72 (120)	2.06 (52)	2.75 (70)
1½ (SAE 24)	12.2 (310)	4.12 (105)	4.72 (120)	2.06 (52)	2.75 (70)

^①3 inch models have Celcon[®] piston/piston ring

Note: Dimensions for 3" can be found on page 79.
Weights for all sizes can be found on page 80.

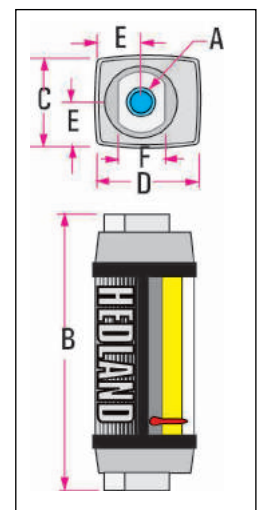

3500/6000 PSI flow meters

For water and other liquids

Ordering information

Nominal port size ^②	Flow range		Pressure drop		Model number (see example below)			Material ⌘	
	gal/min	l/min	50% flow psi (bar)	100% flow psi (bar)	SAE	NPTF	BSPP ^③	Brass 3500 psi	Stainless steel
¼" SAE 6	.02 - 0.2	0.1 - 0.75	3.5 (.24)	4.0 (.28)	H204 ⌘ - 002	H205 ⌘ - 002	H206 ⌘ - 002	B	6000 psi S
	.05 - 0.5	0.2 - 1.9	3.0 (.21)	5.0 (.35)	H204 ⌘ - 005	H205 ⌘ - 005	H206 ⌘ - 005		
	0.1 - 1.0	0.5 - 3.75	4.0 (.28)	9.0 (.62)	H204 ⌘ - 010	H205 ⌘ - 010	H206 ⌘ - 010		
	0.2 - 2.0	1 - 7.5	6.0 (.41)	13 (.90)	H204 ⌘ - 020	H205 ⌘ - 020	H206 ⌘ - 020		
½" SAE 10	0.1 - 1.0	0.5 - 3.75	2.0 (.14)	2.75 (.19)	H604 ⌘ - 001	H605 ⌘ - 001	H606 ⌘ - 001	B	6000 psi S
	0.2 - 2.0	1 - 7.5	2.0 (.14)	3.0 (.21)	H604 ⌘ - 002	H605 ⌘ - 002	H606 ⌘ - 002		
	0.5 - 5.0	2 - 19	3.0 (.21)	6.0 (.41)	H604 ⌘ - 005	H605 ⌘ - 005	H606 ⌘ - 005		
	1 - 10	5 - 38	4.0 (.28)	9.5 (.66)	H604 ⌘ - 010	H605 ⌘ - 010	H606 ⌘ - 010		
	1 - 15	4 - 56	6.5 (.45)	18.5 (1.3)	H604 ⌘ - 015	H605 ⌘ - 015	H606 ⌘ - 015		
¾" SAE 12	0.2 - 2.0	1 - 7.5	1.0 (.07)	2.0 (.14)	H704 ⌘ - 002	H705 ⌘ - 002	H706 ⌘ - 002	B	5000 psi S
	0.5 - 5.0	2 - 19	2.5 (.17)	3.5 (.24)	H704 ⌘ - 005	H705 ⌘ - 005	H706 ⌘ - 005		
	1 - 10	5 - 38	3.5 (.24)	9.0 (.62)	H704 ⌘ - 010	H705 ⌘ - 010	H706 ⌘ - 010		
	2 - 20	10 - 76	4.0 (.28)	9.0 (.62)	H704 ⌘ - 020	H705 ⌘ - 020	H706 ⌘ - 020		
	3 - 30	10 - 115	7.0 (.48)	16.5 (1.1)	H704 ⌘ - 030	H705 ⌘ - 030	H706 ⌘ - 030		
1" SAE 16	0.2 - 2.0	1 - 7.5	1.0 (.07)	2.0 (.14)	H754 ⌘ - 002	H755 ⌘ - 002	H756 ⌘ - 002	B	5000 psi S
	0.5 - 5.0	2 - 19	2.5 (.17)	3.5 (.24)	H754 ⌘ - 005	H755 ⌘ - 005	H756 ⌘ - 005		
	1 - 10	5 - 38	3.5 (.24)	9.0 (.62)	H754 ⌘ - 010	H755 ⌘ - 010	H756 ⌘ - 010		
	2 - 20	10 - 76	4.0 (.28)	9.0 (.62)	H754 ⌘ - 020	H755 ⌘ - 020	H756 ⌘ - 020		
	3 - 30	10 - 115	7.0 (.48)	16.5 (1.1)	H754 ⌘ - 030	H755 ⌘ - 030	H756 ⌘ - 030		
	4 - 40	15 - 150	9.0 (.62)	24 (1.7)	H754 ⌘ - 040	H755 ⌘ - 040	H756 ⌘ - 040		
	5 - 50	20 - 190	12.5 (.86)	34 (2.3)	H754 ⌘ - 050	H755 ⌘ - 050	H756 ⌘ - 050		
	5 - 50	20 - 190	12.5 (.86)	34 (2.3)	H754 ⌘ - 050	H755 ⌘ - 050	H756 ⌘ - 050		
1¼" SAE 20	3 - 30	10 - 110	3.0 (.21)	4.0 (.28)	H804 ⌘ - 030	H805 ⌘ - 030	H806 ⌘ - 030	B	5000 psi S
	5 - 50	20 - 190	3.5 (.24)	7.0 (.48)	H804 ⌘ - 050	H805 ⌘ - 050	H806 ⌘ - 050		
	10 - 75	40 - 280	5.0 (.35)	10.5 (.72)	H804 ⌘ - 075	H805 ⌘ - 075	H806 ⌘ - 075		
	10 - 100	50 - 380	6.5 (.45)	15.0 (1.0)	H804 ⌘ - 100	H805 ⌘ - 100	H806 ⌘ - 100		
	10 - 150	50 - 560	10.5 (.72)	27.5 (1.9)	H804 ⌘ - 150	H805 ⌘ - 150	H806 ⌘ - 150		
1½" SAE 24	3 - 30	10 - 110	3.0 (.21)	4.0 (.28)	H854 ⌘ - 030	H855 ⌘ - 030	H856 ⌘ - 030	B	5000 psi S
	5 - 50	20 - 190	3.5 (.24)	7.0 (.48)	H854 ⌘ - 050	H855 ⌘ - 050	H856 ⌘ - 050		
	10 - 75	40 - 280	5.0 (.35)	10.5 (.72)	H854 ⌘ - 075	H855 ⌘ - 075	H856 ⌘ - 075		
	10 - 100	50 - 380	6.5 (.45)	15.0 (1.0)	H854 ⌘ - 100	H855 ⌘ - 100	H856 ⌘ - 100		
	10 - 150	50 - 560	10.5 (.72)	27.5 (1.9)	H854 ⌘ - 150	H855 ⌘ - 150	H856 ⌘ - 150		
3"	5 - 50	20 - 190	.50 (.03)	.75 (.05)	Not available	H905 ⌘ - 050	H906 ⌘ - 050	800 psi B	Not available
	10 - 100	40 - 360	1.40 (.10)	2.25 (1.6)		H905 ⌘ - 100	H906 ⌘ - 100		
	30 - 150	125 - 575	3.25 (.22)	5.25 (3.6)		H905 ⌘ - 150	H906 ⌘ - 150		
	20 - 275	100 - 1000	11.0 (.76)	18 (1.2)		H905 ⌘ - 275	H906 ⌘ - 275		

② Fractional sizes apply to NPTF and BSPP.

③ 3 inch models have BSPT (BS21) threads.

Example: H 705 B - 030



3500/6000 PSI high temperature

Flow meters for water and other liquids

- Direct reading
- Install in any position
- 360° rotatable guard/scale
- Easier-to-read linear scale
- No flow straighteners or special piping required
- Relatively insensitive to shock and vibration
- Good viscosity stability
- Temperature up to 240°C (500 °F)
- Accuracy ±2% full scale
- Repeatability ±1%
- Special scales available
- Calibrated for 1.0 S.G.

Technical data

Materials:	C360 Brass body, piston and cone T303 stainless body, C360 brass piston and cone
Common parts	
Spider plate: T316 SS Spring: T302 SS Fasteners: T303 SS Seals: Viton® Scale support: T316 SS Guard: cylindrical Pyrex® glass End caps: 2011 - T3 anodized aluminum	Retaining ring: T316 SS Retaining spring: T316 SS Indicator: Nickel-plated carbon steel Internal magnet: Teflon® coated Alnico 8 Bumper: 2011 - T3 anodized aluminum Scale: Polymide
Threads	SAE J1926/1, NPTF ANSI B2.2, BSPP ISO1179
Temperature range	-20 to +400 °F (-29 to +205 °C) continuous +205 to +260 °C (+400 to +500 °F) intermittent Detailed "Pressure vs. temperature" correlation information, see next page.
Pressure rating	
Brass operating	3,500 psi/241 bar max. with a 3:1 safety factor. For high cycle applications, see page conversion information.
Stainless steel operating	6,000 psi/414 bar max. (5,000 psi/345 bar max. for ¼" to 1½" series) with a 3:1 safety factor. For high cycle applications, see page conversion information.
Pressure drop	See ordering information table, next page. For detailed differential pressure charts, see page 62.
Accuracy	±2% of full scale
Repeatability	±1%



Dimensions

A	B	C	D
Nominal port size	Length in (mm)	Width in (mm)	Flats in (mm)
¼ (SAE 6)	6.60 (168)	2.01 (53)	1.25 (32)
½ (SAE 10)	6.60 (168)	2.01 (53)	1.25 (32)
¾ (SAE 12)	7.20 (183)	2.48 (63)	1.50 (38)
1 (SAE 16)	7.20 (183)	2.48 (63)	1.75 (44)
1¼ (SAE 20)	12.20 (310)	4.20 (105)	2.75 (70)
1½ (SAE 24)	12.20 (310)	4.20 (105)	2.75 (70)

Note: Weights for all sizes can be found on page 80.

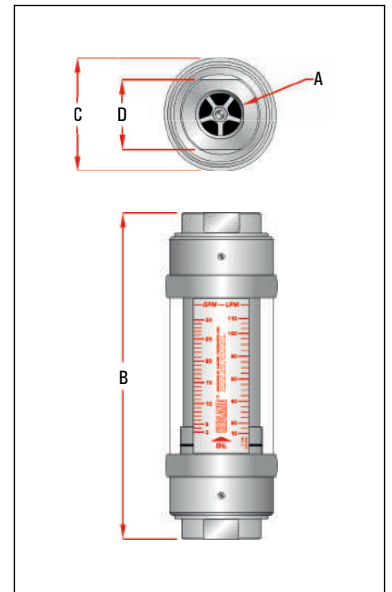

3500/6000 PSI high temperature

Flow meters for water and other liquids

Ordering information

Nominal port size ^①	Flow range		Pressure drop		Model number (see example below)			Material ☒	
	gal/min	l/min	50% flow psi (bar)	100% flow psi (bar)	SAE	NPTF	BSPP ^③	Brass 3500 psi	Stainless steel
¼" SAE 6	0.1 - 1.0	0.5 - 3.75	4.0 (.28)	9.0 (.62)	H204 ☒ - 010 - HT	H205 ☒ - 010 - HT	H206 ☒ - 010 - HT	B	6000 psi S
	0.2 - 2.0	1 - 7.5	6.0 (.41)	13.0 (.90)	H204 ☒ - 020 - HT	H205 ☒ - 020 - HT	H206 ☒ - 020 - HT		
½" SAE 10	0.1 - 1.0	0.5 - 3.75	2.0 (.14)	2.75 (.19)	H604 ☒ - 001 - HT	H605 ☒ - 001 - HT	H606 ☒ - 001 - HT	B	6000 psi S
	0.2 - 2.0	1 - 7.5	2.0 (.14)	3.0 (.21)	H604 ☒ - 002 - HT	H605 ☒ - 002 - HT	H606 ☒ - 002 - HT		
	0.5 - 5.0	2 - 19	3.0 (.21)	6.0 (.41)	H604 ☒ - 005 - HT	H605 ☒ - 005 - HT	H606 ☒ - 005 - HT		
	1 - 10	5 - 38	4.0 (.28)	9.5 (.66)	H604 ☒ - 010 - HT	H605 ☒ - 010 - HT	H606 ☒ - 010 - HT		
	1 - 15	4 - 56	6.5 (.45)	18.5 (1.3)	H604 ☒ - 015 - HT	H605 ☒ - 015 - HT	H606 ☒ - 015 - HT		
¾" SAE 12	0.2 - 2.0	1 - 7.5	1.0 (.07)	2.0 (.14)	H704 ☒ - 002 - HT	H705 ☒ - 002 - HT	H706 ☒ - 002 - HT	B	5000 psi S
	0.5 - 5.0	2 - 19	2.5 (.17)	3.5 (.24)	H704 ☒ - 005 - HT	H705 ☒ - 005 - HT	H706 ☒ - 005 - HT		
	1 - 10	5 - 38	3.5 (.24)	9.0 (.62)	H704 ☒ - 010 - HT	H705 ☒ - 010 - HT	H706 ☒ - 010 - HT		
	2 - 20	10 - 76	4.0 (.28)	9.0 (.62)	H704 ☒ - 020 - HT	H705 ☒ - 020 - HT	H706 ☒ - 020 - HT		
	3 - 30	10 - 115	7.0 (.48)	16.5 (1.1)	H704 ☒ - 030 - HT	H705 ☒ - 030 - HT	H706 ☒ - 030 - HT		
1" SAE 16	0.2 - 2.0	1 - 7.5	1.0 (.07)	2.0 (.14)	H754 ☒ - 002 - HT	H755 ☒ - 002 - HT	H756 ☒ - 002 - HT	B	5000 psi S
	0.5 - 5.0	2 - 19	2.5 (.17)	3.5 (.24)	H754 ☒ - 005 - HT	H755 ☒ - 005 - HT	H756 ☒ - 005 - HT		
	1 - 10	5 - 38	3.5 (.24)	9.0 (.62)	H754 ☒ - 010 - HT	H755 ☒ - 010 - HT	H756 ☒ - 010 - HT		
	2 - 20	10 - 76	4.0 (.28)	9.0 (.62)	H754 ☒ - 020 - HT	H755 ☒ - 020 - HT	H756 ☒ - 020 - HT		
	3 - 30	10 - 115	7.0 (.48)	16.5 (1.1)	H754 ☒ - 030 - HT	H755 ☒ - 030 - HT	H756 ☒ - 030 - HT		
	4 - 40	15 - 150	9.0 (.62)	24.0 (1.7)	H754 ☒ - 040 - HT	H755 ☒ - 040 - HT	H756 ☒ - 040 - HT		
1½" SAE 20	3 - 30	10 - 110	3.0 (.21)	4.0 (.28)	H804 ☒ - 030 - HT	H805 ☒ - 030 - HT	H806 ☒ - 030 - HT	B	5000 psi S
	5 - 50	20 - 190	3.5 (.24)	7.0 (.48)	H804 ☒ - 050 - HT	H805 ☒ - 050 - HT	H806 ☒ - 050 - HT		
	10 - 75	40 - 280	5.0 (.35)	10.5 (.72)	H804 ☒ - 075 - HT	H805 ☒ - 075 - HT	H806 ☒ - 075 - HT		
	10 - 100	50 - 380	6.5 (.45)	15.0 (1.0)	H804 ☒ - 100 - HT	H805 ☒ - 100 - HT	H806 ☒ - 100 - HT		
	10 - 150	50 - 560	10.5 (.72)	27.5 (1.9)	H804 ☒ - 150 - HT	H805 ☒ - 150 - HT	H806 ☒ - 150 - HT		
1½" SAE 24	3 - 30	10 - 110	3.0 (.21)	4.0 (.28)	H854 ☒ - 030 - HT	H855 ☒ - 030 - HT	H856 ☒ - 030 - HT	B	5000 psi S
	5 - 50	20 - 190	3.5 (.24)	7.0 (.48)	H854 ☒ - 050 - HT	H855 ☒ - 050 - HT	H856 ☒ - 050 - HT		
	10 - 75	40 - 280	5.0 (.35)	10.5 (.72)	H854 ☒ - 075 - HT	H855 ☒ - 075 - HT	H856 ☒ - 075 - HT		
	10 - 100	50 - 380	6.5 (.45)	15.0 (1.0)	H854 ☒ - 100 - HT	H855 ☒ - 100 - HT	H856 ☒ - 100 - HT		
	10 - 150	50 - 560	10.5 (.72)	27.5 (1.9)	H854 ☒ - 150 - HT	H855 ☒ - 150 - HT	H856 ☒ - 150 - HT		

①Fractional sizes apply to NPTF and BSPP.

Example: H 705 B - 030 - HT

Note: HT suffix represents standard high temperature configuration.

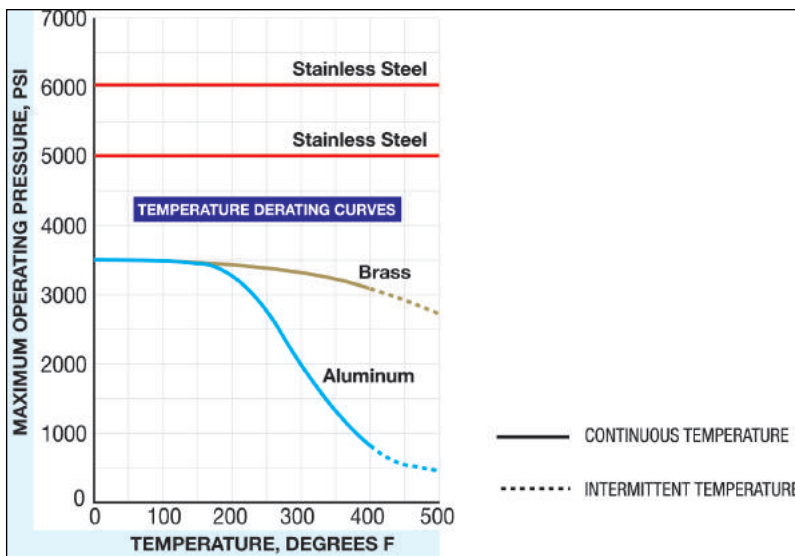
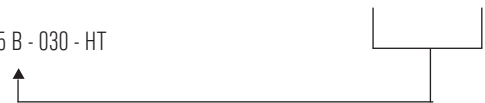

6000 PSI flow meters

For A.P.I. oil / Caustic and corrosive liquids

- Direct reading
- Install in any position
- 360° rotatable guard/scale
- Easier-to-read linear scale
- No flow straighteners or special piping required
- Relatively insensitive to shock and vibration
- Good viscosity stability
- Temperature up to 116°C (240 °F)
- Accuracy ±2% full scale
- Repeatability ±1%
- Special scales available



Technical data

Materials	T316 Stainless body, piston and cone
Common parts	
Spider plate: T316 SS Spring: T316 SS Fasteners: T316 SS Guard seal / Bumper: Buna N Guard: Polycarbonate End caps: Nylon ST	Retaining ring: T316 SS Retaining spring: T316 SS Indicator and internal magnet: PPS / ceramic pressure Seals: Viton® Scale support: 6063 - T6 aluminum
Threads	NPTF ANSI B2.2, BSPP ISO1179
Temperature range	-29 to +116 °C (-20 to +240 °F) for higher temperatures, consult factory
Pressure rating	
Oil / liquids operating	6,000 psi/414 bar max. (5,000 psi/345 bar max for ¾" to 1½" series) with a 3:1 safety factor. For high cycle applications, see page conversion information.
Pressure drop	See ordering information table next page. Detailed differential pressure charts, see page 62.
Accuracy	±2% of full scale, ±7% of full scale for ¼" meters
Repeatability	±1%
Hostile environment option specifications	
Materials	T316 stainless body, piston and cone
Common parts	
Spider plate: T316 SS Spring: T316 SS Fasteners: T316 SS Bumper: T316 SS Seals: Viton® End caps: T316 SS	Retaining ring: T316 SS Retaining spring: T316 SS Indicator: T416 SS Scale support: T316 SS Guard: Cylindrical Pyrex® glass Internal magnet: Teflon® Coated Alnico 8
Temperature range	-29 to +205 °C (-20 to +400 °F) continuous +205 to +260 °C (+400 to +500 °F) intermittent For detailed "Pressure vs. temperature" correlation information, see next page.



Dimensions

A	B	C	D	E	F
Nominal port size	Length in (mm)	Width in (mm)	Depth in (mm)	Offset in (mm)	Flats in (mm)
¼	4.8 (122)	1.68 (43)	1.90 (48)	.84 (21)	.88 (22)
½	6.6 (168)	2.07 (53)	2.40 (61)	1.04 (26)	1.25 (32)
¾	7.2 (183)	2.48 (63)	2.85 (72)	1.24 (32)	1.50 (38)
1	7.2 (183)	2.48 (63)	2.85 (72)	1.24 (32)	1.75 (44)
1¼	12.2 (310)	4.12 (105)	4.72 (120)	2.06 (52)	2.75 (70)
1½	12.2 (310)	4.12 (105)	4.72 (120)	2.06 (52)	2.75 (70)

Note: Weights for all sizes can be found on page 80.

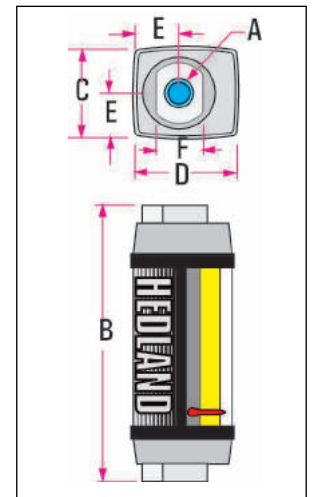

6000 PSI flow meters

For A.P.I. oil / Caustic and corrosive liquids

Ordering information

Nominal port size	Flow range		Pressure drop		Model number (see example below)				Hostile environment option ♦
	gal/min	l/min	50% flow psi (bar)	100% flow psi (bar)	API - oil .876 (S.G.)		Liquids 1.0 (S.G.)		
					NPTF	BSPP	NPSF	BSPP	
¼"	0.1 - 1.0	0.5 - 3.75	4.0 (.28)	9.0 (.62)	6000 psi		6000 psi		HE
	0.2 - 2.0	1 - 7.5	6.0 (.41)	13.0 (.90)	H231X - 010 - ♦ H231X - 020 - ♦	H232X - 010 - ♦ H232X - 020 - ♦	H234X - 010 - ♦ H234X - 020 - ♦	H235X - 010 - ♦ H235X - 020 - ♦	
½"	0.2 - 2.0	1 - 7.5	2.0 (.14)	3.0 (.21)	6000 psi		6000 psi		HE
	0.5 - 5.0	2 - 19	3.0 (.21)	6.0 (.41)	H631X - 002 - ♦ H631X - 005 - ♦	H632X - 002 - ♦ H632X - 005 - ♦	H634X - 002 - ♦ H634X - 005 - ♦	H635X - 002 - ♦ H635X - 005 - ♦	
	1 - 10	5 - 38	4.0 (.28)	9.5 (.66)	H631X - 010 - ♦ H631X - 015 - ♦	H632X - 010 - ♦ H632X - 015 - ♦	H634X - 010 - ♦ H634X - 015 - ♦	H635X - 010 - ♦ H635X - 015 - ♦	
	1 - 15	4 - 56	6.5 (.45)	18.5 (1.3)					
¾"	0.2 - 2.0	1 - 7.5	1.0 (.07)	2.0 (.14)	5000 psi		5000 psi		HE
	0.5 - 5.0	2 - 19	2.5 (.17)	3.5 (.24)	H731X - 002 - ♦ H731X - 005 - ♦	H732X - 002 - ♦ H732X - 005 - ♦	H734X - 002 - ♦ H734X - 005 - ♦	H735X - 002 - ♦ H735X - 005 - ♦	
	1 - 10	5 - 38	3.5 (.24)	9.0 (.62)	H731X - 010 - ♦ H731X - 020 - ♦	H732X - 010 - ♦ H732X - 020 - ♦	H734X - 010 - ♦ H734X - 020 - ♦	H735X - 010 - ♦ H735X - 020 - ♦	
	2 - 20	10 - 76	4.0 (.28)	9.0 (.62)	H731X - 020 - ♦ H731X - 030 - ♦	H732X - 020 - ♦ H732X - 030 - ♦	H734X - 020 - ♦ H734X - 030 - ♦	H735X - 020 - ♦ H735X - 030 - ♦	
	3 - 30	10 - 115	7.0 (.48)	16.5 (1.1)					
1"	0.2 - 2.0	1 - 7.5	1.0 (.07)	2.0 (.14)	5000 psi		5000 psi		HE
	0.5 - 5.0	2 - 19	2.5 (.17)	3.5 (.24)	H741X - 002 - ♦ H741X - 005 - ♦	H742X - 002 - ♦ H742X - 005 - ♦	H744X - 002 - ♦ H744X - 005 - ♦	H745X - 002 - ♦ H745X - 005 - ♦	
	1 - 10	5 - 38	3.5 (.24)	9.0 (.62)	H741X - 010 - ♦ H741X - 020 - ♦	H742X - 010 - ♦ H742X - 020 - ♦	H744X - 010 - ♦ H744X - 020 - ♦	H745X - 010 - ♦ H745X - 020 - ♦	
	2 - 20	10 - 76	4.0 (.28)	9.0 (.62)	H741X - 020 - ♦ H741X - 030 - ♦	H742X - 020 - ♦ H742X - 030 - ♦	H744X - 020 - ♦ H744X - 030 - ♦	H745X - 020 - ♦ H745X - 030 - ♦	
	3 - 30	10 - 115	7.0 (.48)	16.5 (1.1)	H741X - 030 - ♦ H741X - 040 - ♦	H742X - 030 - ♦ H742X - 040 - ♦	H744X - 030 - ♦ H744X - 040 - ♦	H745X - 030 - ♦ H745X - 040 - ♦	
1¼"	3 - 30	10 - 110	3.0 (.21)	4.0 (.28)	5000 psi		5000 psi		HE
	5 - 50	20 - 190	3.5 (.24)	7.0 (.48)	H831X - 030 - ♦ H831X - 050 - ♦	H832X - 030 - ♦ H832X - 050 - ♦	H834X - 030 - ♦ H834X - 050 - ♦	H835X - 030 - ♦ H835X - 050 - ♦	
	10 - 75	40 - 280	5.0 (.35)	10.5 (.72)	H831X - 075 - ♦ H831X - 100 - ♦	H832X - 075 - ♦ H832X - 100 - ♦	H834X - 075 - ♦ H834X - 100 - ♦	H835X - 075 - ♦ H835X - 100 - ♦	
	10 - 100	50 - 380	6.5 (.45)	15.0 (1.0)					
1½"	3 - 30	10 - 110	3.0 (.21)	4.0 (.28)	5000 psi		5000 psi		HE
	5 - 50	20 - 190	3.5 (.24)	7.0 (.48)	H841X - 030 - ♦ H841X - 050 - ♦	H842X - 030 - ♦ H842X - 050 - ♦	H844X - 030 - ♦ H844X - 050 - ♦	H845X - 030 - ♦ H845X - 050 - ♦	
	10 - 75	40 - 280	5.0 (.35)	10.5 (.72)	H841X - 075 - ♦ H841X - 100 - ♦	H842X - 075 - ♦ H842X - 100 - ♦	H844X - 075 - ♦ H844X - 100 - ♦	H845X - 075 - ♦ H845X - 100 - ♦	
	10 - 100	50 - 380	6.5 (.45)	15.0 (1.0)					

Note: Consult factory for availability.

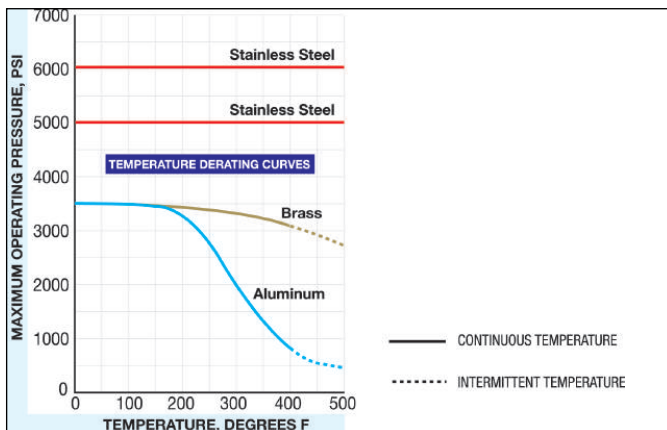
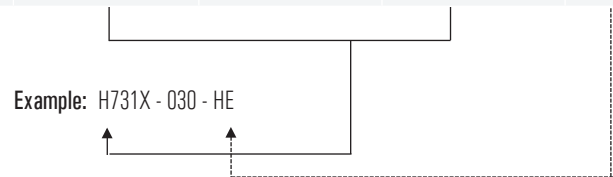

1500 PSI flow meters

For air / Caustic and corrosive gases

- Direct reading
- Install in any position
- 360° rotatable guard/scale
- Easier-to-read linear scale
- No flow straighteners or special piping required
- Relatively insensitive to shock and vibration
- Temperature up to 116°C (240 °F)
- Accuracy ±2% full scale
- Repeatability ±1%
- Special scales available



Technical data

Materials	T316 Stainless body, piston and cone
Common parts	
Spider plate: T316 SS Spring: T316 SS Fasteners: T316 SS Guard seal / Bumper: Buna N Guard: Polycarbonate End caps: Nylon ST	Retaining ring: T316 SS Retaining spring: T316 SS Indicator and internal magnet: PPS / ceramic pressure Seals: Viton® Scale support: 6063 - T6 aluminum
Threads	NPTF ANSI B2.2, BSPP ISO1179
Temperature range	-29 to +116 °C (-20 to +240 °F) for higher temperatures, consult factory.
Pressure rating	
Oil / liquids operating	6,000 psi/414 bar max. (5,000 psi/345 bar max for ¼" to 1½" series) with a 3:1 safety factor. For high cycle applications, see page conversion information.
Pressure drop	See ordering information table next page. Detailed differential pressure charts, see page 62.
Accuracy	±2% of full scale, ±7% of full scale for ¼" meters
Repeatability	±1%
Hostile environment option specifications	
Materials	T316 stainless body, piston and cone
Common parts	
Spider plate: T316 SS Spring: T316 SS Fasteners: T316 SS Bumper: T316 SS Seals: Viton® End caps: T316 SS	Retaining ring: T316 SS Retaining spring: T316 SS Indicator: T416 SS Scale support: T316 SS Guard: Cylindrical Pyrex® glass Internal magnet: Teflon® Coated Alnico 8
Temperature range	-29 to +205 °C (-20 to +400 °F) continuous +205 to +260 °C (+400 to +500 °F) intermittent For detailed "Pressure vs. temperature" correlation information, see next page.



Dimensions

A	B	C	D	E	F
Nominal port size	Length in (mm)	Width in (mm)	Depth in (mm)	Offset in (mm)	Flats in (mm)
¼	4.8 (122)	1.68 (43)	1.90 (48)	.84 (21)	.88 (22)
½	6.6 (168)	2.07 (53)	2.40 (61)	1.04 (26)	1.25 (32)
¾	7.2 (183)	2.48 (63)	2.85 (72)	1.24 (32)	1.50 (38)
1	7.2 (183)	2.48 (63)	2.85 (72)	1.24 (32)	1.75 (44)
1¼	12.2 (310)	4.12 (105)	4.72 (120)	2.06 (52)	2.75 (70)
1½	12.2 (310)	4.12 (105)	4.72 (120)	2.06 (52)	2.75 (70)

Note: Weights for all sizes can be found on page 80.

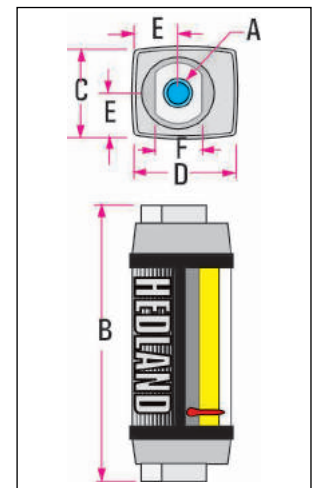

1500 PSI flow meters

For air / Caustic and corrosive gases

Ordering information

Nominal port size	Flow range		Pressure drop		Model number (see example below)		Hostile environment option ♦
	① SCFM	② l/sec	50% flow psi (bar)	100% flow psi (bar)	Gases 1.0 (S.G.)		
					NPTF	BSPP	
¼"	2 - 20	1 - 9	10.15 (0.70)	18.71 (1.29)	H237X - 020 - ♦	H238X - 020 - ♦	n/a
	3 - 30	1.5 - 14	13.75 (0.95)	26.23 (1.81)	H237X - 030 - ♦	H238X - 030 - ♦	
½"	3 - 25	2 - 12	3.73 (0.26)	6.10 (0.42)	H637X - 025 - ♦	H638X - 025 - ♦	HE
	5 - 50	3 - 22	6.04 (0.42)	10.35 (0.71)	H637X - 050 - ♦	H638X - 050 - ♦	
	10 - 100	5 - 47	7.18 (0.50)	13.85 (0.95)	H637X - 100 - ♦	H638X - 100 - ♦	
	15 - 150	7 - 70	8.06 (0.56)	18.49 (1.27)	H637X - 150 - ♦	H638X - 150 - ♦	
¾"	3 - 25	1.5 - 11.5	2.99 (0.21)	5.90 (0.41)	H737X - 025 - ♦	H738X - 025 - ♦	HE
	5 - 50	2 - 23	2.00 (0.14)	3.58 (0.25)	H737X - 050 - ♦	H738X - 050 - ♦	
	10 - 100	5 - 47.5	7.19 (0.50)	12.87 (0.89)	H737X - 100 - ♦	H738X - 100 - ♦	
	15 - 150	7 - 70	4.44 (0.31)	9.52 (0.66)	H737X - 150 - ♦	H738X - 150 - ♦	
	25 - 250	10 - 118	6.27 (0.43)	15.38 (1.06)	H737X - 250 - ♦	H738X - 250 - ♦	
1"	3 - 25	1.5 - 11.5	2.99 (0.21)	5.90 (0.41)	H747X - 025 - ♦	H748X - 025 - ♦	HE
	5 - 50	2 - 23	2.00 (0.14)	3.58 (0.25)	H747X - 050 - ♦	H748X - 050 - ♦	
	10 - 100	5 - 47.5	7.19 (0.50)	12.87(0.89)	H747X - 100 - ♦	H748X - 100 - ♦	
	15 - 150	7 - 70	4.44 (0.31)	9.52 (0.66)	H747X - 150 - ♦	H748X - 150 - ♦	
	25 - 250	10 - 118	6.27(0.43)	15.38 (1.06)	H747X - 250 - ♦	H748X - 250 - ♦	
1¼"	20 - 200	10 - 95	1.89 (0.13)	3.16 (0.22)	H837X - 200 - ♦	H838X - 200 - ♦	HE
	40 - 400	20 - 180	2.53 (0.17)	5.49 (0.38)	H837X - 400 - ♦	H838X - 400 - ♦	
	60 - 600	30 - 280	4.47 (0.31)	10.71 (0.74)	H837X - 600 - ♦	H838X - 600 - ♦	
	80 - 800	50 - 350	6.13 (0.42)	17.14 (1.18)	H837X - 800 - ♦	H838X - 800 - ♦	
1½"	20 - 200	10 - 95	1.89 (0.13)	3.16 (0.22)	H847X - 200 - ♦	H848X - 200 - ♦	HE
	40 - 400	20 - 180	2.53 (0.17)	5.49 (0.38)	H847X - 400 - ♦	H848X - 400 - ♦	
	60 - 600	30 - 280	4.47 (0.31)	10.71 (0.74)	H847X - 600 - ♦	H848X - 600 - ♦	
	80 - 800	50 - 350	6.13 (0.42)	17.14 (1.18)	H847X - 800 - ♦	H848X - 800 - ♦	

Note: Consult factory for availability.

- ① SCFM/PSI multipressure scales are standard.
- ② l/sec/bar multipressure scales are available at no extra charge. Consult factory for other options.

Example: H 737X - 250 - HE



Note: When ordering a l/sec/bar scale, add "S1" suffix to part number

(Example) H737 X - 250 - S1 or H737 X - 250 - HE - S1

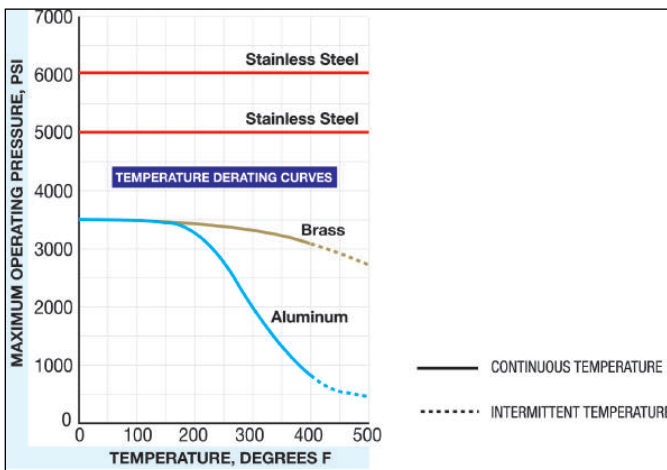

1000/1500 PSI flow meters

For air and other compressed gases

- Direct reading
- Install in any position
- 360° rotatable guard/scale
- Easier-to-read linear scale
- No flow straighteners or special piping required
- Relatively insensitive to shock and vibration
- Temperature up to 116°C (240 °F)
- Accuracy ±2% full scale
- Repeatability ±1%
- Special scales available
- Calibrated for 1.0 S.G.

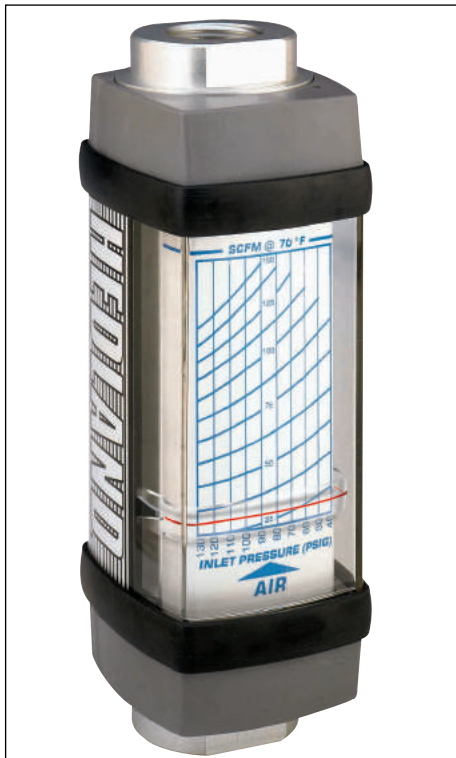

Technical data

Materials	2024 - T351 anodized aluminum body, piston and cone C360 brass body piston and cone ^① , T303 stainless body, 2024 - T351 anodized aluminum piston and cone
Common parts	
Spider plate: T316 SS Spring: T302 SS Fasteners: T303 SS Pressure seals: Viton [®] Guard: Polycarbonate	Retaining ring: T316 SS Retaining spring: T316 SS Indicator and internal magnet: PPS / ceramic Guard seal / bumper: Buna N Scale support: 6063 - T6 aluminum End caps: Nylon ST
Threads	SAE J1926/1, NPTF ANSI B2.2, BSPP ISO1179
Temperature range	-29 to +116 °C (-20 to +240 °F) For higher temperatures, consult factory.
Pressure rating	
Aluminum / brass operating	1,000 psi/69 bar max. (250 psi/17 bar max. for 3" series) with a 10:1 safety factor. For high cycle applications see page conversion information.
Stainless steel operating	1,500 psi/103 bar max. with a 10:1 safety factor. For high cycle applications, see page conversion information.
Pressure drop	See ordering information table next page. For detailed differential pressure charts, see page 62.
Accuracy	±2% of full scale, ±7% of full scale for ¼" meters
Repeatability	±1%

Standard product

Standard product with EP & EG option

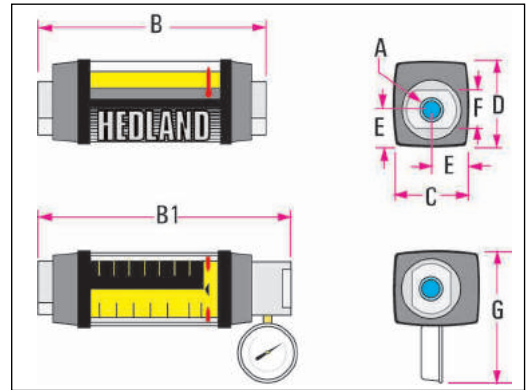

Dimensions

	A	B	B1	C	D	E	F	G
Nominal port size	Length in (mm)	Length in (mm)	Width in (mm)	Depth in (mm)	Offset in (mm)	Flats in (mm)	Height in (mm)	Height in (mm)
¼ (SAE 6)	4.8 (122)	6.12 (155)	1.68 (43)	1.90 (48)	.84 (21)	.88 (22)	5.0 (127)	
½ (SAE 10)	6.6 (168)	8.00 (203)	2.07 (53)	2.40 (61)	1.04 (26)	1.25 (32)	5.4 (137)	
¾ (SAE 12)	7.2 (183)	8.9 (226)	2.48 (63)	2.85 (72)	1.24 (32)	1.50 (38)	5.9 (150)	
1 (SAE 16)	7.2 (183)	8.9 (226)	2.48 (63)	2.85 (72)	1.24 (32)	1.75 (44)	5.9 (150)	
1¼ (SAE 20)	12.2 (310)	13.8 (351)	4.12 (105)	4.72 (120)	2.06 (52)	2.75 (70)	7.2 (183)	
1½ (SAE 24)	12.2 (310)	13.8 (351)	4.12 (105)	4.72 (120)	2.06 (52)	2.75 (70)	7.2 (183)	

Note: Dimensions for 3" meters can be found on page 79.

Weights for all sizes can be found on page 80.

^① 3 inch models have Celcon[®] piston/piston ring

1000/1500 PSI flow meters

For air and other compressed gases

Ordering information

Nominal port size ^②	Flow range		Pressure drop		Model number (see example below)			Material [⊗]			Options [◆]	
	③ SCFM	④ l/sec	50% flow psi (bar)	100% flow psi (bar)	SAE	NPTF	BSPP [Ⓞ]	Aluminium 1000 psi	Brass 1000 psi	Stainless 1500 psi	Ex-tended cap plugged [Ⓞ]	Extended cap with gauge [Ⓞ]
¼" SAE 6	0.5 - 5	0.2 - 2.2	2.51 (0.17)	4.45 (0.31)	H270 ☒ - 005 - ◆	H271 ☒ - 005 - ◆	H272 ☒ - 005 - ◆	A	B	S	EP	EG
	1 - 10	0.5 - 4.75	9.29 (0.64)	16.46 (1.13)	H270 ☒ - 010 - ◆	H271 ☒ - 010 - ◆	H272 ☒ - 010 - ◆					
	2 - 20	1 - 9	10.15 (0.70)	18.71 (1.29)	H270 ☒ - 020 - ◆	H271 ☒ - 020 - ◆	H272 ☒ - 020 - ◆					
	3 - 30	1.5 - 14	13.75 (0.95)	26.23 (1.81)	H270 ☒ - 030 - ◆	H271 ☒ - 030 - ◆	H272 ☒ - 030 - ◆					
½" SAE 10	3 - 25	2 - 12	3.73 (0.26)	6.10 (0.42)	H670 ☒ - 025 - ◆	H671 ☒ - 025 - ◆	H672 ☒ - 025 - ◆	A	B	S	EP	EG
	5 - 50	3 - 22	6.04 (0.42)	10.35 (0.71)	H670 ☒ - 050 - ◆	H671 ☒ - 050 - ◆	H672 ☒ - 050 - ◆					
	10 - 100	5 - 47	7.18 (0.50)	13.85 (0.95)	H670 ☒ - 100 - ◆	H671 ☒ - 100 - ◆	H672 ☒ - 100 - ◆					
	15 - 150	7 - 70	8.06 (0.56)	18.49 (1.27)	H670 ☒ - 150 - ◆	H671 ☒ - 150 - ◆	H672 ☒ - 150 - ◆					
¾" SAE 12	3 - 25	1.5 - 11.5	2.99 (0.21)	5.90 (0.41)	H770 ☒ - 025 - ◆	H771 ☒ - 025 - ◆	H772 ☒ - 025 - ◆	A	B	S	EP	EG
	5 - 50	2 - 23	2.00 (0.14)	3.58 (0.25)	H770 ☒ - 050 - ◆	H771 ☒ - 050 - ◆	H772 ☒ - 050 - ◆					
	10 - 100	5 - 47.5	7.19 (0.50)	12.87 (0.89)	H770 ☒ - 100 - ◆	H771 ☒ - 100 - ◆	H772 ☒ - 100 - ◆					
	15 - 150	7 - 70	4.44 (0.31)	9.52 (0.66)	H770 ☒ - 150 - ◆	H771 ☒ - 150 - ◆	H772 ☒ - 150 - ◆					
	25 - 250	10 - 118	6.27 (0.43)	15.38 (1.06)	H770 ☒ - 250 - ◆	H771 ☒ - 250 - ◆	H772 ☒ - 250 - ◆					
1" SAE 16	3 - 25	1.5 - 11.5	2.99 (0.21)	5.90 (0.41)	H790 ☒ - 025 - ◆	H791 ☒ - 025 - ◆	H792 ☒ - 025 - ◆	A	B	S	EP	EG
	5 - 50	2 - 23	2.00 (0.14)	3.58 (0.25)	H790 ☒ - 050 - ◆	H791 ☒ - 050 - ◆	H792 ☒ - 050 - ◆					
	10 - 100	5 - 47.5	7.19 (0.50)	12.87 (0.89)	H790 ☒ - 100 - ◆	H791 ☒ - 100 - ◆	H792 ☒ - 100 - ◆					
	15 - 150	7 - 70	4.44 (0.31)	9.52 (0.66)	H790 ☒ - 150 - ◆	H791 ☒ - 150 - ◆	H792 ☒ - 150 - ◆					
	25 - 250	10 - 118	6.27 (0.43)	15.38 (1.06)	H790 ☒ - 250 - ◆	H791 ☒ - 250 - ◆	H792 ☒ - 250 - ◆					
1¼" SAE 20	20 - 200	10 - 95	1.89 (0.13)	3.16 (0.22)	H870 ☒ - 200 - ◆	H871 ☒ - 200 - ◆	H872 ☒ - 200 - ◆	A	B	S	EP	EG
	40 - 400	20 - 180	2.53 (0.17)	5.49 (0.38)	H870 ☒ - 400 - ◆	H871 ☒ - 400 - ◆	H872 ☒ - 400 - ◆					
	60 - 600	30 - 280	4.47 (0.31)	10.71 (0.74)	H870 ☒ - 600 - ◆	H871 ☒ - 600 - ◆	H872 ☒ - 600 - ◆					
	80 - 800	50 - 350	6.13 (0.42)	17.14 (1.18)	H870 ☒ - 800 - ◆	H871 ☒ - 800 - ◆	H872 ☒ - 800 - ◆					
	100 - 1000	50 - 475	9.84 (0.68)	28.45 (1.96)	H870 ☒ - 999 - ◆	H871 ☒ - 999 - ◆	H872 ☒ - 999 - ◆					
1½" SAE 24	20 - 200	10 - 95	1.89 (0.13)	3.16 (0.22)	H890 ☒ - 200 - ◆	H891 ☒ - 200 - ◆	H892 ☒ - 200 - ◆	A	B	S	EP	EG
	40 - 400	20 - 180	2.53 (0.17)	5.49 (0.38)	H890 ☒ - 400 - ◆	H891 ☒ - 400 - ◆	H892 ☒ - 400 - ◆					
	60 - 600	30 - 280	4.47 (0.31)	10.71 (0.74)	H890 ☒ - 600 - ◆	H891 ☒ - 600 - ◆	H892 ☒ - 600 - ◆					
	80 - 800	50 - 350	6.13 (0.42)	17.14 (1.18)	H890 ☒ - 800 - ◆	H891 ☒ - 800 - ◆	H892 ☒ - 800 - ◆					
	100 - 1000	50 - 475	9.84 (0.68)	28.45 (1.96)	H890 ☒ - 999 - ◆	H891 ☒ - 999 - ◆	H892 ☒ - 999 - ◆					
3"	100 - 1400	75 - 750	10.0 (0.69)	16.0 (1.10)	Not available	H971 ☒ - 140 - ◆	H972 ☒ - 140 - ◆	250 psi		Not available		
	200 - 2200	75 - 1130	10.0 (0.69)	16.0 (1.10)		H971 ☒ - 220 - ◆	H972 ☒ - 220 - ◆	A	B			

- ② Fractional sizes apply to NPTF and BSPP.
- ③ SCFM/psi multipressure scales are standard.
- ④ l/sec/bar multipressure
- ⑤ Scales are available at no extra charge.
- ⑥ 3 inch models have BSPT (BS21) threads
EP and EG options are only available with NPTF and BSPP models.

Example: H 771 A - 030 - EP

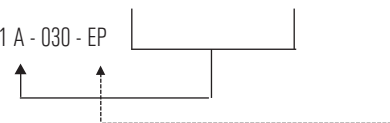

Note: When ordering a l/sec/bar scale, add "S1" suffix to part number.

Example: H771 A - 250 - S1 or H771 A - 250 - EG - S1

600 PSI test kits

For air and other compressed gases

- Direct reading
- Install in any position
- 360° rotatable guard/scale
- Easier-to-read linear scale
- No flow straighteners or special piping required
- Relatively insensitive to shock and vibration
- Temperature up to 116°C (240 °F)
- Accuracy ±2% full scale
- Repeatability ±1%
- Special scales available



Technical data

Materials	2024 - T351 anodized aluminum body, piston and cone, C360 brass body, piston and cone T303 stainless body, 2024 - T351 anodized aluminum piston and cone
Common parts	
Spider plate: T316 SS Spring: T302 SS Fasteners: T303 SS Pressure seals: Viton® Guard: Polycarbonate End caps: Nylon ST	Retaining ring: T316 SS Retaining spring: T316 SS Indicator and internal magnet: PPS / ceramic Guard seal / bumper: Buna N Scale support: 6063 - T6 aluminum
Threads	NPTF ANSI B2.2, BSPP ISO1179
Temperature range	-29 to +116 °C (-20 to +240 °F)
Pressure rating	
Aluminum / brass operating	600 psi/41 bar max. with a 10:1 safety factor. For high cycle applications, see page conversion information.
Stainless steel operating	600 psi/41 bar max. with a 10:1 safety factor. For high cycle applications, see page conversion information.
Pressure drop	See ordering information table next page. For detailed differential pressure charts, see page 62.
Accuracy	±2% of full scale, ±7% of full scale for ¼" meters
Repeatability	±1%
Pressure gauge	Glycerin dampened, 0 - 160 psi / 0 - 10 bar pressure range available on all test kits.
Load valve	½" to 1½" nickel-plated brass ball valve with chrome-plated brass ball and Teflon® seals.
Silencer (optional)	Brass body with 40 micron porous sintered bronze filter.

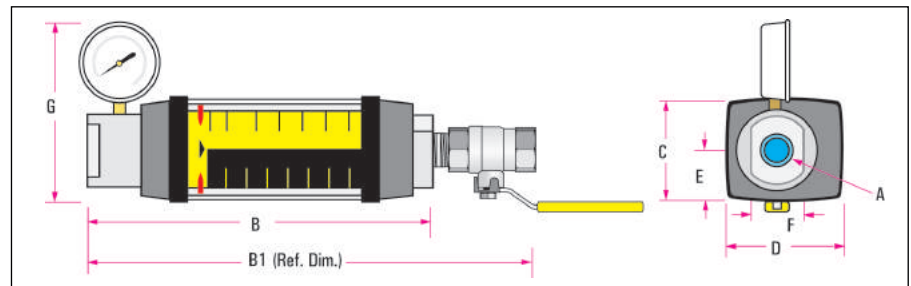

Dimensions

	A	B	B1	C	D	E	F	G
Nominal port size	Length in (mm)	Length in (mm)	Width in (mm)	Depth in (mm)	Offset in (mm)	Flats in (mm)	Height in (mm)	
¼	6.12 (155)	8.38 (213)	1.68 (43)	1.90 (48)	.84 (21)	.88 (22)	5.0 (127)	
½	8.00 (203)	11.0 (279)	2.07 (53)	2.40 (61)	1.04 (26)	1.25 (32)	5.4 (137)	
¾	8.90 (226)	12.38 (315)	2.48 (63)	2.85 (72)	1.24 (32)	1.50 (38)	5.9 (150)	
1	8.90 (226)	12.38 (315)	2.48 (63)	2.85 (72)	1.24 (32)	1.75 (44)	5.9 (150)	
1¼	13.80 (351)	18.39 (465)	4.12 (105)	4.72 (120)	2.06 (52)	2.75 (70)	7.2 (183)	
1½	13.80 (351)	18.39 (465)	4.12 (105)	4.72 (120)	2.06 (52)	2.75 (70)	7.2 (183)	

Note: Weights for all sizes can be found on page 80.
BSPP Test Kits include outlet adapter.

600 PSI test kits

For air and other compressed gases

Ordering information

Nominal port size	Flow range		Pressure drop		Model number (see example below)		Material ⌘		
	① SCFM	② l/sec	50% flow psi (bar)	100% flow psi (bar)	NPTF	BSPP	Aluminium 600 psi	Brass 600 psi	Stainless 600 psi
¼"	0.5 - 5	0.2 - 2.2	3.38 (0.23)	5.32 (0.37)	H271 ⌘ - 005 - TK	H272 ⌘ - 005 - TK	A	B	S
	1 - 10	0.5 - 4.75	8.08 (0.56)	17.33 (1.19)	H271 ⌘ - 010 - TK	H272 ⌘ - 010 - TK			
	2 - 20	1 - 9	11.02 (0.76)	19.64 (1.35)	H271 ⌘ - 020 - TK	H272 ⌘ - 020 - TK			
	3 - 30	1.5 - 14	14.62 (1.01)	27.10 (1.87)	H271 ⌘ - 030 - TK	H272 ⌘ - 030 - TK			
½"	3 - 25	2 - 12	4.60 (0.32)	6.97 (0.48)	H671 ⌘ - 025 - TK	H672 ⌘ - 025 - TK	A	B	S
	5 - 50	3 - 22	6.91 (0.48)	11.22 (0.77)	H671 ⌘ - 050 - TK	H672 ⌘ - 050 - TK			
	10 - 100	5 - 47	8.67 (0.60)	14.72 (1.01)	H671 ⌘ - 100 - TK	H672 ⌘ - 100 - TK			
	15 - 150	7 - 70	8.93 (0.62)	19.36 (1.33)	H671 ⌘ - 150 - TK	H672 ⌘ - 150 - TK			
¾"	3 - 25	1.5 - 11.5	3.86 (0.27)	6.77 (0.47)	H771 ⌘ - 025 - TK	H772 ⌘ - 025 - TK	A	B	S
	5 - 50	2 - 23	2.87 (0.20)	4.45 (0.31)	H771 ⌘ - 050 - TK	H772 ⌘ - 050 - TK			
	10 - 100	5 - 47.5	8.06 (0.56)	13.74 (0.95)	H771 ⌘ - 100 - TK	H772 ⌘ - 100 - TK			
	15 - 150	7 - 70	5.31 (0.37)	10.39 (0.72)	H771 ⌘ - 150 - TK	H772 ⌘ - 150 - TK			
	25 - 250	10 - 118	7.14 (0.49)	16.25 (1.12)	H771 ⌘ - 250 - TK	H772 ⌘ - 250 - TK			
1"	3 - 25	1.5 - 15	3.86 (0.27)	6.77 (0.47)	H791 ⌘ - 025 - TK	H792 ⌘ - 025 - TK	A	B	S
	5 - 50	2 - 23	2.87 (0.20)	4.45 (0.31)	H791 ⌘ - 050 - TK	H792 ⌘ - 050 - TK			
	10 - 100	5 - 47.5	8.06 (0.56)	13.74 (0.95)	H791 ⌘ - 100 - TK	H792 ⌘ - 100 - TK			
	15 - 150	7 - 70	5.31 (0.37)	10.39 (0.72)	H791 ⌘ - 150 - TK	H792 ⌘ - 150 - TK			
	25 - 250	10 - 118	7.14 (0.49)	16.25 (1.12)	H791 ⌘ - 250 - TK	H792 ⌘ - 250 - TK			
1¼"	20 - 200	10 - 95	2.76 (0.19)	4.03 (0.28)	H871 ⌘ - 200 - TK	H872 ⌘ - 200 - TK	A	B	S
	40 - 400	20 - 180	3.40 (0.23)	6.36 (0.44)	H871 ⌘ - 400 - TK	H872 ⌘ - 400 - TK			
	60 - 600	30 - 280	5.34 (0.37)	11.58 (0.80)	H871 ⌘ - 600 - TK	H872 ⌘ - 600 - TK			
	80 - 800	50 - 350	7.00 (0.48)	18.01(1.24)	H871 ⌘ - 800 - TK	H872 ⌘ - 800 - TK			
	100 - 1000	50 - 475	10.71 (0.74)	29.32 (2.02)	H871 ⌘ - 999 - TK	H872 ⌘ - 999 - TK			
1½"	20 - 200	10 - 95	2.76 (0.19)	4.03 (0.28)	H891 ⌘ - 200 - TK	H892 ⌘ - 200 - TK	A	B	S
	40 - 400	20 - 180	3.40 (0.23)	6.36 (0.44)	H891 ⌘ - 400 - TK	H892 ⌘ - 400 - TK			
	60 - 600	30 - 280	5.34 (0.37)	11.58 (0.80)	H891 ⌘ - 600 - TK	H892 ⌘ - 600 - TK			
	80 - 800	50 - 350	7.00 (0.48)	18.01(1.24)	H891 ⌘ - 800 - TK	H892 ⌘ - 800 - TK			
	100 - 1000	50 - 475	10.71 (0.74)	29.32 (2.02)	H891 ⌘ - 999 - TK	H892 ⌘ - 999 - TK			

① SCFM/psi multipressure scales are standard.

Example: H 771 A - 250 - TK

② L/sec-bar multipressure scales are available at no extra charge.



Note: Consult factory for other options.

Note: When ordering a L/sec-bar scale, add "S1" suffix to part number.

Example: H771 A - 250 - TK - S1

Flow-Alert flow switches (microswitch)

For liquids / Air and other compressed gases

- Automatically signals alarm if flow is too high or too low
- Automatically opens or closes electrical circuits
- Triggers warning lights, buzzers and other devices
- Shuts down pumps and/or other equipment to protect your operation against permanent damage
- Available from 1/4" to 1 1/2" sizes in aluminum, brass and stainless
- Installs in any position
- Easier-to-read linear scale
- No flow straighteners or special piping requirements
- Relatively insensitive to shock and vibration
- Special scales available



Technical data

Materials	2024 - T351 anodized aluminum body, piston and cone C360 brass body, piston and cone 303 stainless body, 2024 - T351 anodized aluminum piston and cone Oil, PE, WBF, & air meters T303 stainless body, C360 brass piston and cone (water meters) T316 stainless body, piston and cone
Petroleum (oil) common parts	
Spider plate: T316 SS Spring: T302 SS Fasteners: T303 SS Pressure seals: Viton® Lens: Polycarbonate	Retaining ring: SAE 1070/1090 carbon steel Retaining spring: SAE 1070/1090 carbon steel Indicator and internal magnet: PPS / ceramic Enclosure seal: Silicone gasket Scale support: 6063 - T6 aluminum
Phosphate ester (PE) common parts	
Spider plate: T316 SS Spring: T302 SS Fasteners: T303 SS Pressure seals: EPR Lens: Polycarbonate	Retaining ring: SAE 1070/1090 carbon steel Retaining spring: SAE 1070/1090 carbon steel Indicator and internal magnet: PPS / ceramic Enclosure seal: Silicone gasket Scale support: 6063 - T6 aluminum
Water-based (WBF), water, air common parts	
Spider plate: T316 SS Spring: T302 SS Fasteners: T303 SS Pressure seals: Viton® Lens: Polycarbonate	Retaining ring: T316 SS Retaining spring: T316 SS Indicator and internal magnet: PPS / ceramic Enclosure seal: Silicone gasket Scale support: 6063 - T6 aluminum
API oil / air / caustic and corrosive liquids and gases	
Spider plate: T316 SS Spring: T316 SS Fasteners: T316 SS Pressure seals: Viton® Lens: Polycarbonate	Retaining ring: T316 SS Retaining spring: T316 SS Indicator and internal magnet: PPS / ceramic Enclosure seal: Silicone gasket Scale support: 6063 - T6 aluminum
Threads	SAE J1926/1, NPTF ANSI B2.2, BSPP ISO1179
Temperature range	-29 to +116 °C (-20 to +240 °F)
Pressure rating	
Aluminum / brass operating	
Liquids	3,500 psi/241 bar max. with a 3:1 safety factor.
Gases	1,000 psi/69 bar max. with a 10:1 safety factor. For high cycle applications, see page conversion information.
Stainless steel operating	
Liquids	6,000 psi/414 bar max. with a 3:1 safety factor.
Gases	1,500 psi/103 bar max. with a 10:1 safety factor. For high cycle applications, see page conversion information.
Accuracy	± 2% of full scale
Repeatability	± 1%

Flow-Alert flow switches (microswitch)

For liquids / Air and other compressed gases

Dimensions

A	B	C	D	E	F	G	H	I	J	K
Nominal port size	Length in (mm)	Length in (mm)	Length in (mm)	Width in (mm)	Width in (mm)	Width in (mm)	Width in (mm)	Depth in (mm)	Offset in (mm)	Hole dia in (mm)
¼ (SAE 6)	6.6 (168)	5.27 (134)	6.41 (163)	6.00 (152)	3.23 (82)	3.00 (76)	4.20 (107)	2.94 (75)	1.51 (38)	.31 (8)
½ (SAE 10)	6.6 (168)	5.27 (134)	6.41 (163)	6.00 (152)	3.23 (82)	3.00 (76)	4.20 (107)	2.94 (75)	1.51 (38)	.31 (8)
¾ (SAE 12)	7.2 (183)	5.27 (134)	7.04 (179)	6.00 (152)	3.60 (91)	3.00 (76)	4.20 (107)	2.94 (75)	1.27 (32)	.31 (8)
1 (SAE 16)	7.2 (183)	5.27 (134)	7.04 (179)	6.00 (152)	3.60 (91)	3.00 (76)	4.20 (107)	2.94 (75)	1.27 (32)	.31 (8)
1¼ (SAE 20)	12.2 (310)	10.68 (271)	11.65 (296)	7.63 (194)	4.84 (123)	3.82 (97)	5.02 (128)	4.50 (114)	2.20 (56)	.31 (8)
1½ (SAE 24)	12.2 (310)	10.68 (271)	11.65 (296)	7.63 (194)	4.84 (123)	3.82 (97)	5.02 (128)	4.50 (114)	2.20 (56)	.31 (8)

Enclosure

Material	Anodized and epoxy powder-coated aluminum with polycarbonate lens.
Seals	Silicone gasket between enclosure and lens. Viton® O-rings between enclosure and flow meter body.
Connection	Pig-tail conductor (standard) with water-tight strain relief. Other connections, including quick-disconnect, are available – consult factory for details.
Fastener	T303 SS
Rating	NEMA 12 & 13 (IP52/54)

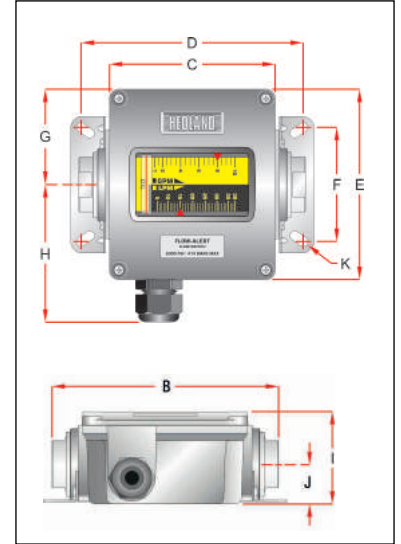

Electrical circuitry

Adjustable flow-alert signal: Single (1) or double (2) switch, pre-wired single-pole, double-throw (SPDT)
UL recognized and CSA certified with high or low flow limit setting, adjustable over the entire flow measuring range. Other switches are available – consult factory for details. Optional 2,4 m (8 ft) cables are available – consult factory for details.

10A @ 250 VAC maximum, 0.5A @ 125 VDC maximum.

All flow-alert sizes (¼ to 1½ inch series) are offered in single (1) switch or double (2) switch models.

The single switch model is supplied with a 34" length of 4-wire #18 AWG jacketed cable.

The double switch model is supplied with an 18" length of 7-wire #16 AWG jacketed cable.

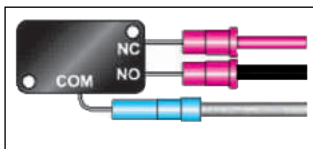

One (1) switch 4-wire cable

Red	Normally closed (NC)
Black	Normally open (NO)
White	Common (COM)
Green	Ground

Two (2) switch 7-wire cable

Switch #1

Red	Normally closed (NC)
Black	Normally open (NO)
White	Common (COM)

Switch #2

Orange	Normally closed (NC)
Blue	Normally open (NO)
White/black	Common (COM)
Green	Ground

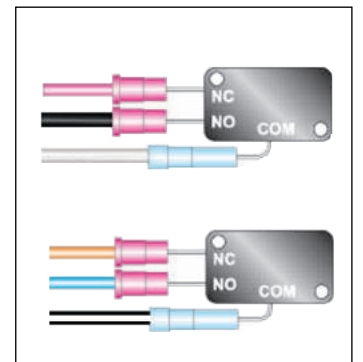

Note: Weights for all sizes can be found on page 80.

Flow-Alert flow switches (reed switch)

For liquids / Air and other compressed gases

- No mechanical linkage
- Automatically signals alarm if flow is too high or too low
- Available from 1/4" to 1 1/2" sizes in aluminum, brass and stainless
- Installs in any position
- Easier-to-read linear scale
- No flow straighteners or special piping requirements
- Relatively insensitive to shock and vibration
- Special scales available



Technical data

Materials	2024 - T351 anodized aluminum body, piston and cone C360 brass body, piston and cone T303 stainless body, 2024 T351 anodized aluminum piston and cone (Oil, PE, WBF, & air meters) T303 stainless body, C360 brass piston and cone (water meters) T316 stainless body, piston and cone
Petroleum common parts	
Spider plate: T316 SS	Retaining ring: SAE 1070/1090 carbon steel
Spring: T302 SS	Retaining spring: SAE 1070/1090 carbon steel
Fasteners: T303 SS	Indicator: T400 series stainless
Pressure seals: Viton®	Internal magnet: Teflon® coated Alnico 8
Lens: Polycarbonate	Switch carrier: Aluminum
Enclosure seal: Silicone gasket	Scale support: 6063 - T6 aluminum
Phosphat ester (PE) common parts	
Spider plate: T316 SS	Retaining ring: SAE 1070/1090 carbon steel
Spring: T302 SS	Retaining spring: SAE 1070/1090 carbon steel
Fasteners: T303 SS	Indicator: T400 series stainless
Pressure seals: EPR	Internal magnet: Teflon® coated Alnico 8
Lens: Polycarbonate	Switch carrier: Aluminum
Scale support: 6063 - T6 aluminum	Enclosure seal: Silicone gasket
Water based (WBF), water, air, common parts:	
Spider plate: T316 SS	Retaining ring: T316 SS
Spring: T302 SS	Retaining spring: T316 SS
Fasteners: T303 SS	Indicator: T400 series stainless
Pressure seals: Viton®	Internal magnet: Teflon® coated Alnico 8
Switch carrier: Aluminum	Lens: Polycarbonate
Scale support: 6063 - T6 aluminum	Enclosure seal: Silicone gasket
API oil / air / caustic and corrosive liquids and gases	
Spider plate: T316 SS	Retaining ring: T316 SS
Spring: T316 SS	Retaining spring: T316 SS
Fasteners: T316 SS	Indicator: T400 series stainless
Pressure seals: Viton®	Internal magnet: Teflon® coated Alnico 8
Lens: Polycarbonate	Switch carrier: Aluminum
Scale support: 6063 - T6 aluminum	Enclosure seal: Silicone gasket
Threads	SAE J1926/1, NPTF ANSI B2.2, BSPP ISO1179
Temperature range	-29 to +116 °C (-20 to +240 °F)
Pressure rating	
Aluminum / brass operating	
Liquids	3,500 psi/241 bar max. with a 3:1 safety factor.
Gases	1,000 psi/69 bar max. with a 10:1 safety factor. For high cycle applications, see page conversion information.
Stainless steel operating	
Liquids	6,000 psi/414 bar max. with a 3:1 safety factor.
Gases	1,500 psi/103 bar max. with a 10:1 safety factor. For high cycle applications, see page conversion information.
Accuracy	± 2% of full scale, ± 7% of full scale for 4.8" (122 mm) length 1/4" meters.
Repeatability	± 1%

Flow-Alert flow switches (reed switch)

For liquids / Air and other compressed gases

Dimensions

A	B	C	D	E	F	G	H	I	J	K
Nominal port size	Length in (mm)	Length in (mm)	Length in (mm)	Width in (mm)	Width in (mm)	Width in (mm)	Width in (mm)	Depth in (mm)	Offset in (mm)	Hole dia. in (mm)
¼ (SAE 6)	6.6 (168)	5.27 (134)	6.41 (163)	6.00 (152)	3.23 (82)	3.00 (76)	4.20 (107)	2.94 (75)	1.51 (38)	.31 (8)
½ (SAE 10)	6.6 (168)	5.27 (134)	6.41 (163)	6.00 (152)	3.23 (82)	3.00 (76)	4.20 (107)	2.94 (75)	1.51 (38)	.31 (8)
¾ (SAE 12)	7.2 (183)	5.27 (134)	7.04 (179)	6.00 (152)	3.60 (91)	3.00 (76)	4.20 (107)	2.94 (75)	1.27 (32)	.31 (8)
1 (SAE 16)	7.2 (183)	5.27 (134)	7.04 (179)	6.00 (152)	3.60 (91)	3.00 (76)	4.20 (107)	2.94 (75)	1.27 (32)	.31 (8)
1¼ (SAE 20)	12.2 (310)	10.68 (271)	11.65 (296)	7.63 (194)	4.84 (123)	3.82 (97)	5.02 (128)	4.50 (114)	2.20 (56)	.31 (8)
1½ (SAE 24)	12.2 (310)	10.68 (271)	11.65 (296)	7.63 (194)	4.84 (123)	3.82 (97)	5.02 (128)	4.50 (114)	2.20 (56)	.31 (8)

Dimensions

A	B	C	D	E	F
Nominal port size	Length in (mm)	Width in (mm)	Depth in (mm)	Offset in (mm)	Flats in (mm)
¼ (SAE 6)	4.8 (122)	1.68 (43)	1.90 (48)	.84 (21)	.88 (22)

Enclosure

Material	Anodized and epoxy powder-coated aluminum with polycarbonate lens.
Seals	Silicone gasket between enclosure and lens. Viton® O-rings between enclosure and flow meter body.
Connection	4-pin (IP65)
Fastener	T303 SS
Rating	NEMA 12 & 13 (IP 52/54)

Electrical specifications

Adjustable flow-alert signal: Single (1) or double (2) reed switch, pre-wired single-pole, single-throw (SPST-NO) normally open; or single-pole, single-throw (SPST-NC) normally closed. UL recognized and CSA certified with high or low flow limit setting, adjustable over the entire flow measuring range.

Contact form	SPST-NO	SPST-NC
Electrical specification		
Contact rating	10 Watts max	5 Watts max
Voltage, switching	50 VDC max	50 VDC max
Current (resistive), switching	0.500 A max	0.500 A max
Operating specification		
Contact resistance, initial	0.100 Ω max	0.100 Ω max
Operating temperature	-20 to +116 °C (20 to +240 °F)	-20 to +116 °C (20 to +240 °F)

Note: Weights for all sizes can be found on page 80.

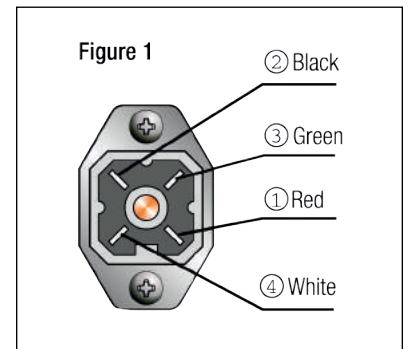
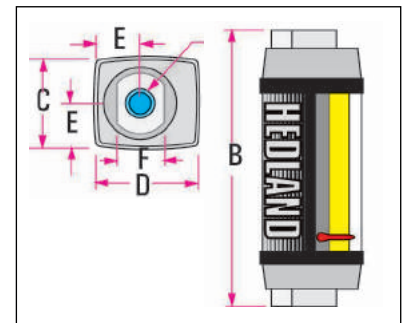
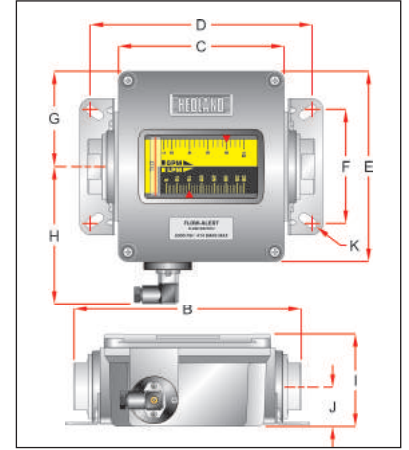
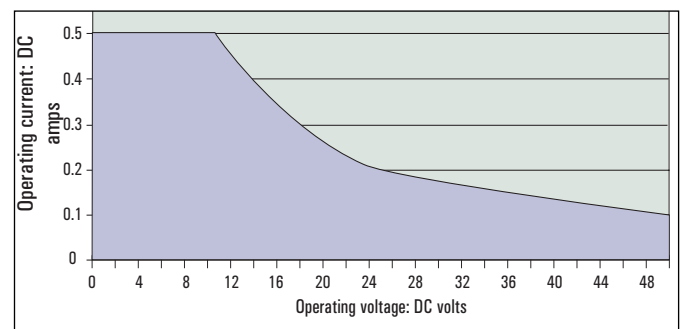
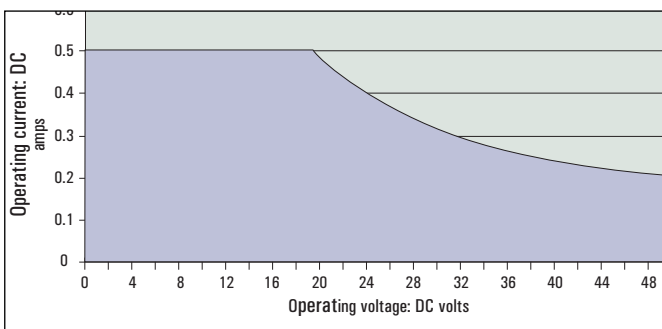

Electrical circuitry

The low switch is supplied with 15 feet of shielded, 4-wire #22 AWG PVC jacketed cable, color coded as follows: 1) red, 2) black, 3) green, 4) white for double (2) reed switch.

MR flow transmitters

For liquids / Air and other compressed gases

- Full line of multi-functional remote flow indicators and transmitters
- Operate as part of a totally integrated electronic process control/data acquisition system
- Non-contact sensor electronics
- Electronic signal conditioning circuit
- Digital flow rate and total flow indication
- Proportional analog output
- In-field compensation for:
 - Specific gravity of all fluids
 - Viscosity of petroleum based fluids
 - Specific gravity, pressure, and temperature of pneumatic systems
- CE compliant
- Exceeds US and meets European standards for EMI/EMC
- US patent 7,130,750



Technical data

Materials	2024 - T351 anodized aluminum body, piston and cone C360 brass body, piston and cone T303 stainless body, 2024 - T351 anodized aluminum piston and cone (Oil, PE, WBF, & air meters) T303 stainless body, C360 brass piston and cone (Water meters) T316 stainless body, piston and cone
Petroleum (oil) common parts	
Spider plate: T316 SS Spring: T302 SS Fasteners: T303 SS Pressure seals: Viton® Lens: Polycarbonate	Retaining ring: SAE 1070/1090 carbon steel Retaining spring: SAE 1070/1090 carbon steel Internal magnet: Teflon® coated Alnico 8 Enclosure seal: Silicone gasket
Phosphate ester (PE) common parts	
Spider plate: T316 SS Spring: T302 SS Fasteners: T303 SS Pressure seals: EPR Lens: Polycarbonate	Retaining ring: SAE 1070/1090 carbon steel Retaining spring: SAE 1070/1090 carbon steel Internal magnet: Teflon® coated Alnico 8 Enclosure seal: Silicone gasket
Water based (WBF), water, air common parts	
Spider plate: T316 SS Spring: T302 SS Fasteners: T303 SS Lens: Polycarbonate Pressure seals: Viton®	Retaining ring: T316 SS Retaining spring: T316 SS Internal magnet: Teflon® coated Alnico 8 Enclosure seal: Silicone gasket
API oil, air, caustic and corrosive liquids and gases	
Spider plate: T316 SS Spring: T316 SS Fasteners: T316 SS Pressure seals: Viton® Lens: Polycarbonate	Retaining ring: T316 SS Retaining spring: T316 SS Internal magnet: Teflon® coated Alnico 8 Enclosure seal: Silicone gasket
Threads	SAE J1926/1, NPTF ANSI B2.2, BSPP ISO1179
Temperature range	-20 to +240 °F (-29 to +116 °C)
Pressure range	
Aluminum / brass operating	
Liquids	3,500 psi/241 bar maximum with a 3:1 safety factor.
Gases	1,000 psi/69 bar maximum with a 10:1 safety factor. For high cycle applications, see page conversion information.
Stainless steel operating	
Liquids	(1/4" to 1/2") - 6,000 psi/414 bar maximum with a 3:1 safety factor
Liquids	(3/4" to 1 1/2") - 5,000 psi/345 bar maximum with a 3:1 safety factor
Gases	1,500 psi/103 bar maximum with a 10:1 safety factor. For high cycle applications, see page conversion information.
Accuracy	±2% of full scale
Repeatability	1%

MR flow transmitters

For liquids / Air and other compressed gases

Schematics

The transmitter can be wired in various configurations to allow interface with many different types of data collection and control instrumentation.

Schematics 1 & 2 represent typical wiring for a target powered by either AC power or DC supply. Schematics 3 & 4 will be utilized when the flow transmitter is operated with loop-powered process indicators or dataloggers that do not have external sensor excitation available.

Enclosure

Material	Anodized and epoxy powder-coated aluminum with polycarbonate lens
Seals	Silicone gaskets between enclosure and lens Viton® O-rings between enclosure and flow meter body.
Connection	4-pin standard, see figure 2. Other connections available, consult factory for details.
Fasteners	T303 SS
Rating	NEMA 12 & 13 (IP 52/54)

Electrical specification

Power requirement	0-5 VDC output: 10-30 VDC at 0.75W maximum 0-10 VDC output: 12-30 VDC at 0.75W maximum 4-20 mA output: loop-powered, 30 VDC maximum
Power consumption	25 mA maximum
Analog outputs	0-5 VDC and 0-10 VDC into 10,000 ohms minimum 4-20 mA into 1000 ohms maximum, see figure 1
Circuit protection	Reverse polarity and current limiting
Transmission	
Distance	4-20 mA limited by cable resistance 0-5 VDC and 0-10 VDC 300 m (1000 ft) maximum
Isolation	Inherently isolated from the piping system
Display	Fixed or toggle modes of operation for rate and totalizer display 8 digit, 0.70" high numeric display for rate and total 8 digit, 0.35" high alphanumeric display for units and setup
Temperature drift	50 ppm / °C (max)
Analog output	Resolution - 1:4000
Transient	
Over-voltages	Category 3, in accordance with IEC 664
Pollution degree	Category 2, in accordance with IEC 664
Approvals	EMC directive 89/336/EEC

	DC output connection	Loop power connection
2 Black:	No connection	(-) 4-20 mA out
3 Green:	0 VDC	No connection
1 Red:	(+) DC power	(+) 4-20 mA in
4 White:	0-5 VDC or 0-10 VDC output	No connection

Figure 2: Electrical 4-pin connection

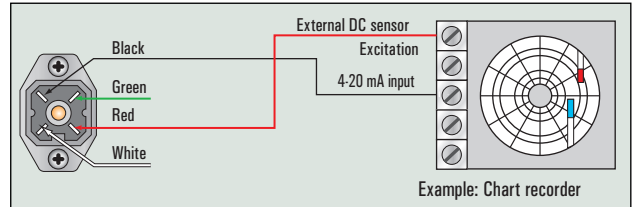

Schematic 1: 4-20 mA connection using target power supply

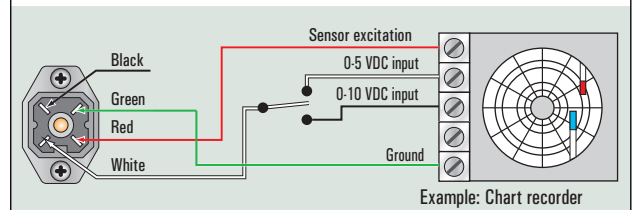

Schematic 2: 0-5 Vdc or 0-10 Vdc connection using target power supply

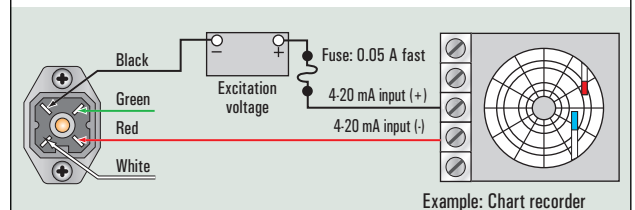

Schematic 3: 4-20 mA connection using target external power supply

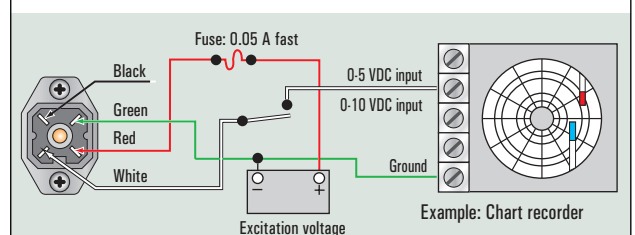

Schematic 4: 0-5 Vdc or 0-10 Vdc connection using target external power supply

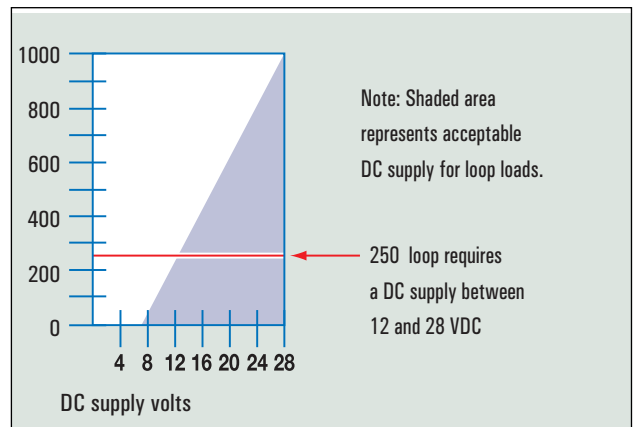

Figure 1: Load limitations (4-20 mA output only)

MR flow transmitters

For liquids / Air and other compressed gases

Dimensions

A	B	C	D	E	F	G	H	I	J	K
Nominal port size	Length in (mm)	Length in (mm)	Length in (mm)	Width in (mm)	Width in (mm)	Width in (mm)	Width in (mm)	Depth in (mm)	Offset in (mm)	Hole dia. in (mm)
¼ (SAE 6)	6.60 (168)	5.27 (134)	6.41 (163)	6.00 (152)	3.23 (82)	3.00 (76)	4.20 (107)	2.94 (75)	1.51 (38)	.31 (8)
½ (SAE 10)	6.60 (168)	5.27 (134)	6.41 (163)	6.00 (152)	3.23 (82)	3.00 (76)	4.20 (107)	2.94 (75)	1.51 (38)	.31 (8)
¾ (SAE 12)	7.20 (183)	5.27 (134)	7.04 (179)	6.00 (152)	3.60 (91)	3.00 (76)	4.20 (107)	2.94 (75)	1.27 (32)	.31 (8)
1 (SAE 16)	7.20 (183)	5.27 (134)	7.04 (179)	6.00 (152)	3.60 (91)	3.00 (76)	4.20 (107)	2.94 (75)	1.27 (32)	.31 (8)
1¼ (SAE 20)	12.20 (310)	10.68 (271)	11.65 (296)	7.63 (194)	4.84 (123)	3.82 (97)	5.02 (128)	4.50 (114)	2.20 (56)	.31 (8)
1½ (SAE 24)	12.20 (310)	10.68 (271)	11.65 (296)	7.63 (194)	4.84 (123)	3.82 (97)	5.02 (128)	4.50 (114)	2.20 (56)	.31 (8)

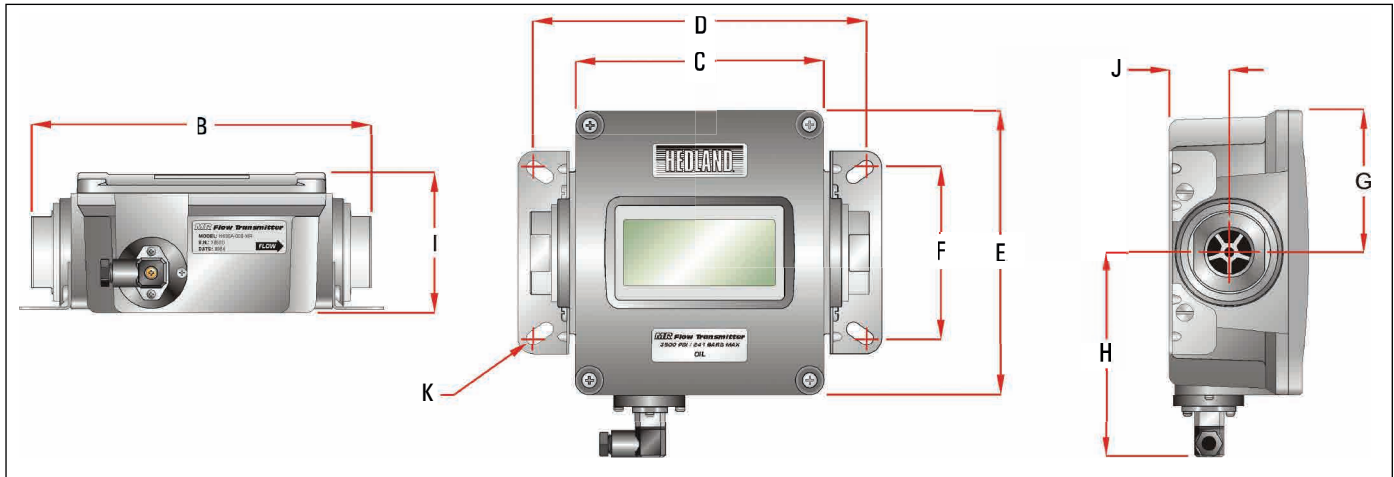

Optional remote display and signal processor

We also offer the F6700/F6750 series digital display with integrated signal processor capabilities to further enhance the utility of the MR flow transmitters. In addition to remote flow monitoring, these units can be configured to provide alarm processing and communication options including RS232, RS485, ModBus®, Profibus and DeviceNet.



Flow-Alert flow switches and flow transmitters

For petroleum fluids

Ordering information

Nominal port size ^①	Flow range		Model number (see example below)			Material ⌘			Options ♦		
	gal/min	l/min	SAE	NPTF	BSPP	Aluminium 3500 psi	Brass 3500 psi	Stainless steel	Flow-Alert 1 switch / 2 switch	Flow-Alert reed switch	Multiple output sensor
¼" SAE 6	.02 - 0.2	0.1 - 0.75	H200 ⌘ - 002 - ♦	H201 ⌘ - 002 - ♦	H202 ⌘ - 002 - ♦	A	B	6000 psi S	Not available		Not available
	.05 - 0.5	0.2 - 1.9	H200 ⌘ - 005 - ♦	H201 ⌘ - 005 - ♦	H202 ⌘ - 005 - ♦						
¼" SAE 6	0.1 - 1.0	0.5 - 3.75	H200 ⌘ - 010 - ♦	H201 ⌘ - 010 - ♦	H202 ⌘ - 010 - ♦	A	B	6000 psi S	F1/F2		MR
	0.2 - 2.0	1.0 - 7.5	H200 ⌘ - 020 - ♦	H201 ⌘ - 020 - ♦	H202 ⌘ - 020 - ♦						
½" SAE 10	0.1 - 1.0	0.5 - 3.75	H600 ⌘ - 001 - ♦	H601 ⌘ - 001 - ♦	H602 ⌘ - 001 - ♦	A	B	6000 psi S	F1/F2		MR
	0.2 - 2.0	1 - 7.5	H600 ⌘ - 002 - ♦	H601 ⌘ - 002 - ♦	H602 ⌘ - 002 - ♦						
	0.5 - 5.0	2 - 19	H600 ⌘ - 005 - ♦	H601 ⌘ - 005 - ♦	H602 ⌘ - 005 - ♦						
	1 - 10	5 - 38	H600 ⌘ - 010 - ♦	H601 ⌘ - 010 - ♦	H602 ⌘ - 010 - ♦						
	1 - 15	4 - 56	H600 ⌘ - 015 - ♦	H601 ⌘ - 015 - ♦	H602 ⌘ - 015 - ♦						
¾" SAE 12	0.2 - 2.0	1 - 7.5	H700 ⌘ - 002 - ♦	H701 ⌘ - 002 - ♦	H702 ⌘ - 002 - ♦	A	B	5000 psi S	F1/F2	See options below	MR
	0.5 - 5.0	2 - 19	H700 ⌘ - 005 - ♦	H701 ⌘ - 005 - ♦	H702 ⌘ - 005 - ♦						
	1 - 10	5 - 38	H700 ⌘ - 010 - ♦	H701 ⌘ - 010 - ♦	H702 ⌘ - 010 - ♦						
	2 - 20	10 - 76	H700 ⌘ - 020 - ♦	H701 ⌘ - 020 - ♦	H702 ⌘ - 020 - ♦						
	3 - 30	10 - 115	H700 ⌘ - 030 - ♦	H701 ⌘ - 030 - ♦	H702 ⌘ - 030 - ♦						
1" SAE 16	0.2 - 2.0	1 - 7.5	H760 ⌘ - 002 - ♦	H761 ⌘ - 002 - ♦	H762 ⌘ - 002 - ♦	A	B	5000 psi S	F1/F2	See options below	MR
	0.5 - 5.0	2 - 19	H760 ⌘ - 005 - ♦	H761 ⌘ - 005 - ♦	H762 ⌘ - 005 - ♦						
	1 - 10	5 - 38	H760 ⌘ - 010 - ♦	H761 ⌘ - 010 - ♦	H762 ⌘ - 010 - ♦						
	2 - 20	10 - 76	H760 ⌘ - 020 - ♦	H761 ⌘ - 020 - ♦	H762 ⌘ - 020 - ♦						
	3 - 30	10 - 115	H760 ⌘ - 030 - ♦	H761 ⌘ - 030 - ♦	H762 ⌘ - 030 - ♦						
1¼" SAE 20	3 - 30	10 - 110	H800 ⌘ - 030 - ♦	H801 ⌘ - 030 - ♦	H802 ⌘ - 030 - ♦	A	B	5000 psi S	F1/F2		MR
	5 - 50	20 - 190	H800 ⌘ - 050 - ♦	H801 ⌘ - 050 - ♦	H802 ⌘ - 050 - ♦						
	10 - 75	40 - 280	H800 ⌘ - 075 - ♦	H801 ⌘ - 075 - ♦	H802 ⌘ - 075 - ♦						
	10 - 100	50 - 380	H800 ⌘ - 100 - ♦	H801 ⌘ - 100 - ♦	H802 ⌘ - 100 - ♦						
	10 - 150	50 - 560	H800 ⌘ - 150 - ♦	H801 ⌘ - 150 - ♦	H802 ⌘ - 150 - ♦						
1½" SAE 24	3 - 30	10 - 110	H860 ⌘ - 030 - ♦	H861 ⌘ - 030 - ♦	H862 ⌘ - 030 - ♦	A	B	5000 psi S	F1/F2		MR
	5 - 50	20 - 190	H860 ⌘ - 050 - ♦	H861 ⌘ - 050 - ♦	H862 ⌘ - 050 - ♦						
	10 - 75	40 - 280	H860 ⌘ - 075 - ♦	H861 ⌘ - 075 - ♦	H862 ⌘ - 075 - ♦						
	10 - 100	50 - 380	H860 ⌘ - 100 - ♦	H861 ⌘ - 100 - ♦	H862 ⌘ - 100 - ♦						
	10 - 150	50 - 560	H860 ⌘ - 150 - ♦	H861 ⌘ - 150 - ♦	H862 ⌘ - 150 - ♦						

① Fractional sizes apply to NPTF and BSPP.

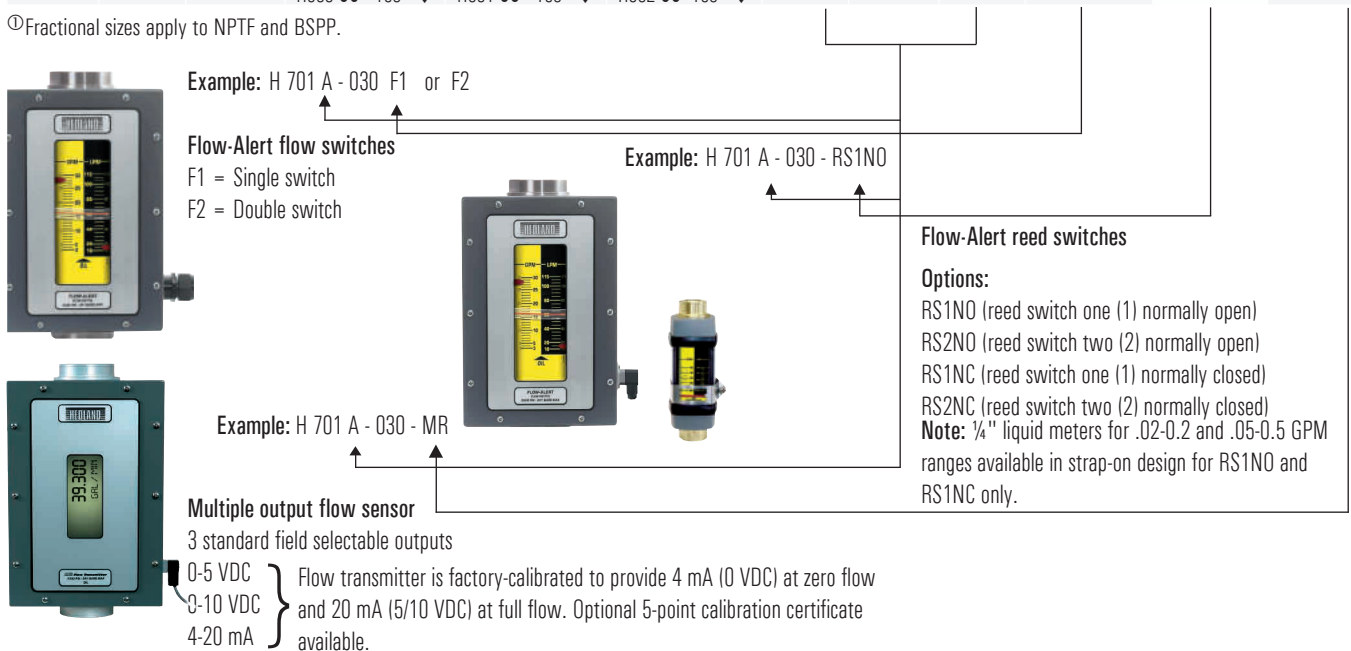

Flow-Alert flow switches and flow transmitters

For phosphate ester fluids

Ordering information

Nominal port size ①	Flow range		Model number (see Example below)			Material ⌘			Options ◆		
	gal/min	l/min	SAE	NPTF	BSPF	Aluminium 3500 psi	Brass 3500 psi	Stainless steel	Flow-Alert 1 switch 2 switch	Flow-Alert reed switch	Multiple output sensor
¼" SAE 6	.02 - 0.2	0.1 - 0.75	H294 ⌘ - 002 - ◆	H295 ⌘ - 002 - ◆	H296 ⌘ - 002 - ◆	A	B	6000 psi S	Not available		Not available
	.05 - 0.5	0.2 - 1.9	H294 ⌘ - 005 - ◆	H295 ⌘ - 005 - ◆	H296 ⌘ - 005 - ◆						
¼" SAE 6	0.1 - 1.0	0.5 - 3.75	H294 ⌘ - 010 - ◆	H295 ⌘ - 010 - ◆	H296 ⌘ - 010 - ◆	A	B	6000 psi S	F1/F2		MR
	0.2 - 2.0	1.0 - 7.5	H294 ⌘ - 020 - ◆	H295 ⌘ - 020 - ◆	H296 ⌘ - 020 - ◆						
½" SAE 10	0.1 - 1.0	0.5 - 3.75	H694 ⌘ - 001 - ◆	H695 ⌘ - 001 - ◆	H696 ⌘ - 001 - ◆	A	B	6000 psi S	F1/F2		MR
	0.2 - 2.0	1 - 7.5	H694 ⌘ - 002 - ◆	H695 ⌘ - 002 - ◆	H696 ⌘ - 002 - ◆						
	0.5 - 5.0	2 - 19	H694 ⌘ - 005 - ◆	H695 ⌘ - 005 - ◆	H696 ⌘ - 005 - ◆						
	1 - 10	5 - 38	H694 ⌘ - 010 - ◆	H695 ⌘ - 010 - ◆	H696 ⌘ - 010 - ◆						
¾" SAE 12	1 - 15	4 - 56	H694 ⌘ - 015 - ◆	H695 ⌘ - 015 - ◆	H696 ⌘ - 015 - ◆	A	B	5000 psi S	F1/F2	See	MR
	0.2 - 2.0	1 - 7.5	H794 ⌘ - 002 - ◆	H795 ⌘ - 002 - ◆	H796 ⌘ - 002 - ◆						
	0.5 - 5.0	2 - 19	H794 ⌘ - 005 - ◆	H795 ⌘ - 005 - ◆	H796 ⌘ - 005 - ◆						
	1 - 10	5 - 38	H794 ⌘ - 010 - ◆	H795 ⌘ - 010 - ◆	H796 ⌘ - 010 - ◆						
	2 - 20	10 - 76	H794 ⌘ - 020 - ◆	H795 ⌘ - 020 - ◆	H796 ⌘ - 020 - ◆						
1" SAE 16	3 - 30	10 - 115	H794 ⌘ - 030 - ◆	H795 ⌘ - 030 - ◆	H796 ⌘ - 030 - ◆	A	B	5000 psi S	F1/F2	options below	MR
	0.2 - 2.0	1 - 7.5	H764 ⌘ - 002 - ◆	H765 ⌘ - 002 - ◆	H766 ⌘ - 002 - ◆						
	0.5 - 5.0	2 - 19	H764 ⌘ - 005 - ◆	H765 ⌘ - 005 - ◆	H766 ⌘ - 005 - ◆						
	1 - 10	5 - 38	H764 ⌘ - 010 - ◆	H765 ⌘ - 010 - ◆	H766 ⌘ - 010 - ◆						
	2 - 20	10 - 76	H764 ⌘ - 020 - ◆	H765 ⌘ - 020 - ◆	H766 ⌘ - 020 - ◆						
	3 - 30	10 - 115	H764 ⌘ - 030 - ◆	H765 ⌘ - 030 - ◆	H766 ⌘ - 030 - ◆						
1¼" SAE 20	4 - 40	15 - 150	H764 ⌘ - 040 - ◆	H765 ⌘ - 040 - ◆	H766 ⌘ - 040 - ◆	A	B	5000 psi S	F1/F2		MR
	5 - 50	20 - 190	H764 ⌘ - 050 - ◆	H765 ⌘ - 050 - ◆	H766 ⌘ - 050 - ◆						
	3 - 30	10 - 110	H894 ⌘ - 030 - ◆	H895 ⌘ - 030 - ◆	H896 ⌘ - 030 - ◆						
	5 - 50	20 - 190	H894 ⌘ - 050 - ◆	H895 ⌘ - 050 - ◆	H896 ⌘ - 050 - ◆						
1½" SAE 24	10 - 100	50 - 380	H894 ⌘ - 100 - ◆	H895 ⌘ - 100 - ◆	H896 ⌘ - 100 - ◆	A	B	5000 psi S	F1/F2		MR
	10 - 150	50 - 560	H894 ⌘ - 150 - ◆	H895 ⌘ - 150 - ◆	H896 ⌘ - 150 - ◆						
	3 - 30	10 - 110	H864 ⌘ - 030 - ◆	H865 ⌘ - 030 - ◆	H866 ⌘ - 030 - ◆						
	5 - 50	20 - 190	H864 ⌘ - 050 - ◆	H865 ⌘ - 050 - ◆	H866 ⌘ - 050 - ◆						
1½" SAE 24	10 - 75	40 - 280	H864 ⌘ - 075 - ◆	H865 ⌘ - 075 - ◆	H866 ⌘ - 075 - ◆	A	B	5000 psi S	F1/F2		MR
	10 - 100	50 - 380	H864 ⌘ - 100 - ◆	H865 ⌘ - 100 - ◆	H866 ⌘ - 100 - ◆						
	10 - 150	50 - 560	H864 ⌘ - 150 - ◆	H865 ⌘ - 150 - ◆	H866 ⌘ - 150 - ◆						
	10 - 150	50 - 560	H864 ⌘ - 150 - ◆	H865 ⌘ - 150 - ◆	H866 ⌘ - 150 - ◆						

① Fractional sizes apply to NPTF and BSPF.

Example: H 795 A - 030 - F1 or F2

Flow-Alert flow switches
 F1 = Single switch
 F2 = Double switch

Example: H 701 A - 030 - RS1N0

Flow-Alert reed switches
Options
 RS1N0 (reed switch one (1) normally open)
 RS2N0 (reed switch two (2) normally open)
 RS1NC (reed switch one (1) normally closed)
 RS2NC (reed switch two (2) normally closed)

Note: ¼" liquid meters for .02-0.2 and .05-0.5 GPM ranges available in strap-on design for RS1N0 and RS1NC only.

Example: H 795 A - 030 - MR

Multiple output flow sensor
 3 standard field selectable outputs
 0-5 VDC
 0-10 VDC
 4-20 mA

Flow transmitter is factory-calibrated to provide 4 mA (0 VDC) at zero flow and 20 mA (5/10 VDC) at full flow. Optional 5-point calibration certificate available.

Flow-Alert flow switches and flow transmitters

For water-based fluids (water/oil emulsions)

Ordering information

Nominal port size ^①	Flow range		Model number (see example: below)			Material ☒			Options ♦		
	gal/min	l/min	SAE	NPTF	BSPP	Aluminium 3500 psi	Brass 3500 psi	Stainless steel	Flow-alert 1 switch / 2 switch	Flow-alert reed switch	Multiple output sensor
¼" SAE 6	.02 - 0.2	0.1 - 0.75	H212 ☒ - 002 - ♦	H213 ☒ - 002 - ♦	H214 ☒ - 002 - ♦	A	B	6000 psi S	Not available		Not available
	.05 - 0.5	0.2 - 1.9	H212 ☒ - 005 - ♦	H213 ☒ - 005 - ♦	H214 ☒ - 005 - ♦						
¼" SAE 6	0.1 - 1.0	0.5 - 3.75	H212 ☒ - 010 - ♦	H213 ☒ - 010 - ♦	H214 ☒ - 010 - ♦	A	B	6000 psi S	F1/F2		MR
	0.2 - 2.0	1.0 - 7.5	H212 ☒ - 020 - ♦	H213 ☒ - 020 - ♦	H214 ☒ - 020 - ♦						
½" SAE 10	0.1 - 1.0	0.5 - 3.75	H612 ☒ - 001 - ♦	H613 ☒ - 001 - ♦	H614 ☒ - 001 - ♦	A	B	6000 psi S	F1/F2		MR
	0.2 - 2.0	1 - 7.5	H612 ☒ - 002 - ♦	H613 ☒ - 002 - ♦	H614 ☒ - 002 - ♦						
	0.5 - 5.0	2 - 19	H612 ☒ - 005 - ♦	H613 ☒ - 005 - ♦	H614 ☒ - 005 - ♦						
	1 - 10	5 - 38	H612 ☒ - 010 - ♦	H613 ☒ - 010 - ♦	H614 ☒ - 010 - ♦						
	1 - 15	4 - 56	H612 ☒ - 015 - ♦	H613 ☒ - 015 - ♦	H614 ☒ - 015 - ♦						
¾" SAE 12	0.2 - 2.0	1 - 7.5	H712 ☒ - 002 - ♦	H713 ☒ - 002 - ♦	H714 ☒ - 002 - ♦	A	B	5000 psi S	F1/F2	See	MR
	0.5 - 5.0	2 - 19	H712 ☒ - 005 - ♦	H713 ☒ - 005 - ♦	H714 ☒ - 005 - ♦						
	1 - 10	5 - 38	H712 ☒ - 010 - ♦	H713 ☒ - 010 - ♦	H714 ☒ - 010 - ♦						
	2 - 20	10 - 76	H712 ☒ - 020 - ♦	H713 ☒ - 020 - ♦	H714 ☒ - 020 - ♦						
	3 - 30	10 - 115	H712 ☒ - 030 - ♦	H713 ☒ - 030 - ♦	H714 ☒ - 030 - ♦						
1" SAE 16	0.2 - 2.0	1 - 7.5	H782 ☒ - 002 - ♦	H783 ☒ - 002 - ♦	H784 ☒ - 002 - ♦	A	B	5000 psi S	F1/F2	options below	MR
	0.5 - 5.0	2 - 19	H782 ☒ - 005 - ♦	H783 ☒ - 005 - ♦	H784 ☒ - 005 - ♦						
	1 - 10	5 - 38	H782 ☒ - 010 - ♦	H783 ☒ - 010 - ♦	H784 ☒ - 010 - ♦						
	2 - 20	10 - 76	H782 ☒ - 020 - ♦	H783 ☒ - 020 - ♦	H784 ☒ - 020 - ♦						
	3 - 30	10 - 115	H782 ☒ - 030 - ♦	H783 ☒ - 030 - ♦	H784 ☒ - 030 - ♦						
	4 - 40	15 - 150	H782 ☒ - 040 - ♦	H783 ☒ - 040 - ♦	H784 ☒ - 040 - ♦						
	5 - 50	20 - 190	H782 ☒ - 050 - ♦	H783 ☒ - 050 - ♦	H784 ☒ - 050 - ♦						
1¼" SAE 20	3 - 30	10 - 110	H812 ☒ - 030 - ♦	H813 ☒ - 030 - ♦	H814 ☒ - 030 - ♦	A	B	5000 psi S	F1/F2		MR
	5 - 50	20 - 190	H812 ☒ - 050 - ♦	H813 ☒ - 050 - ♦	H814 ☒ - 050 - ♦						
	10 - 75	40 - 280	H812 ☒ - 075 - ♦	H813 ☒ - 075 - ♦	H814 ☒ - 075 - ♦						
	10 - 100	50 - 380	H812 ☒ - 100 - ♦	H813 ☒ - 100 - ♦	H814 ☒ - 100 - ♦						
	10 - 150	50 - 560	H812 ☒ - 150 - ♦	H813 ☒ - 150 - ♦	H814 ☒ - 150 - ♦						
1½" SAE 24	3 - 30	10 - 110	H882 ☒ - 030 - ♦	H883 ☒ - 030 - ♦	H884 ☒ - 030 - ♦	A	B	5000 psi S	F1/F2		MR
	5 - 50	20 - 190	H882 ☒ - 050 - ♦	H883 ☒ - 050 - ♦	H884 ☒ - 050 - ♦						
	10 - 75	40 - 280	H882 ☒ - 075 - ♦	H883 ☒ - 075 - ♦	H884 ☒ - 075 - ♦						
	10 - 100	50 - 380	H882 ☒ - 100 - ♦	H883 ☒ - 100 - ♦	H884 ☒ - 100 - ♦						
	10 - 150	50 - 560	H882 ☒ - 150 - ♦	H883 ☒ - 150 - ♦	H884 ☒ - 150 - ♦						

① Fractional sizes apply to NPTF and BSPP.

Example: H 713 A - 030 - F1 or F2

Flow-Alert flow switches
 F1 = Single switch
 F2 = Double switch

Example: H 701 A - 030 - RS1NO

Flow-Alert reed switches/Options
 RS1NO (reed switch one (1) normally open)
 RS2NO (reed switch two (2) normally open)
 RS1NC (reed switch one (1) normally closed)
 RS2NC (reed switch two (2) normally closed)
Note: ¼" liquid meters for .02-0.2 and .05-0.5 GPM ranges available in strap-on design for RS1NO and RS1NC only.

Example: H 713 A - 030 - MR

Multiple output flow sensor
 3 standard field selectable outputs
 0-5 VDC }
 0-10 VDC } Flow transmitter is factory-calibrated to provide 4 mA (0 VDC) at zero flow and 20 mA (5/10 VDC) at full flow. Optional 5-point calibration certificate available.
 4-20 mA }

Flow-Alert flow switches and flow transmitters

For water fluids

Ordering information

Nominal port size ^①	Flow range		Model number (see example below)			Material ☒		Options ◆		
	gal/min	l/min	SAE	NPTF	BSPF	Brass 3500 psi	Stainless steel	Flow-Alert 1 switch / 2 switch	Flow-Alert reed switch	Multiple output sensor
¼" SAE 6	.02 - 0.2	0.1 - 0.75	H204 ☒ - 002 - ◆	H205 ☒ - 002 - ◆	H206 ☒ - 002 - ◆	B	6000 psi S	Not available		Not available
	.05 - 0.5	0.2 - 1.9	H204 ☒ - 005 - ◆	H205 ☒ - 005 - ◆	H206 ☒ - 005 - ◆					
¼" SAE 6	0.1 - 1.0	0.5 - 3.75	H204 ☒ - 010 - ◆	H205 ☒ - 010 - ◆	H206 ☒ - 010 - ◆	B	6000 psi S	F1/F2		MR
	0.2 - 2.0	1.0 - 7.5	H204 ☒ - 020 - ◆	H205 ☒ - 020 - ◆	H206 ☒ - 020 - ◆					
½" SAE 10	0.1 - 1.0	0.5 - 3.75	H604 ☒ - 001 - ◆	H605 ☒ - 001 - ◆	H606 ☒ - 001 - ◆	B	6000 psi S	F1/F2		MR
	0.2 - 2.0	1 - 7.5	H604 ☒ - 002 - ◆	H605 ☒ - 002 - ◆	H606 ☒ - 002 - ◆					
	0.5 - 5.0	2 - 19	H604 ☒ - 005 - ◆	H605 ☒ - 005 - ◆	H606 ☒ - 005 - ◆					
	1 - 10	5 - 38	H604 ☒ - 010 - ◆	H605 ☒ - 010 - ◆	H606 ☒ - 010 - ◆					
	1 - 15	4 - 56	H604 ☒ - 015 - ◆	H605 ☒ - 015 - ◆	H606 ☒ - 015 - ◆					
¾" SAE 12	0.2 - 2.0	1 - 7.5	H704 ☒ - 002 - ◆	H705 ☒ - 002 - ◆	H706 ☒ - 002 - ◆	B	5000 psi S	F1/F2	See	MR
	0.5 - 5.0	2 - 19	H704 ☒ - 005 - ◆	H705 ☒ - 005 - ◆	H706 ☒ - 005 - ◆					
	1 - 10	5 - 38	H704 ☒ - 010 - ◆	H705 ☒ - 010 - ◆	H706 ☒ - 010 - ◆					
	2 - 20	10 - 76	H704 ☒ - 020 - ◆	H705 ☒ - 020 - ◆	H706 ☒ - 020 - ◆					
	3 - 30	10 - 115	H704 ☒ - 030 - ◆	H705 ☒ - 030 - ◆	H706 ☒ - 030 - ◆					
1" SAE 16	0.2 - 2.0	1 - 7.5	H754 ☒ - 002 - ◆	H755 ☒ - 002 - ◆	H756 ☒ - 002 - ◆	B	5000 psi S	F1/F2	options	MR
	0.5 - 5.0	2 - 19	H754 ☒ - 005 - ◆	H755 ☒ - 005 - ◆	H756 ☒ - 005 - ◆					
	1 - 10	5 - 38	H754 ☒ - 010 - ◆	H755 ☒ - 010 - ◆	H756 ☒ - 010 - ◆					
	2 - 20	10 - 76	H754 ☒ - 020 - ◆	H755 ☒ - 020 - ◆	H756 ☒ - 020 - ◆				below	
	3 - 30	10 - 115	H754 ☒ - 030 - ◆	H755 ☒ - 030 - ◆	H756 ☒ - 030 - ◆					
	4 - 40	15 - 150	H754 ☒ - 040 - ◆	H755 ☒ - 040 - ◆	H756 ☒ - 040 - ◆					
1¼" SAE 20	3 - 30	10 - 110	H804 ☒ - 030 - ◆	H805 ☒ - 030 - ◆	H806 ☒ - 030 - ◆	B	5000 psi S	F1/F2		MR
	5 - 50	20 - 190	H804 ☒ - 050 - ◆	H805 ☒ - 050 - ◆	H806 ☒ - 050 - ◆					
	10 - 75	40 - 280	H804 ☒ - 075 - ◆	H805 ☒ - 075 - ◆	H806 ☒ - 075 - ◆					
	10 - 100	50 - 380	H804 ☒ - 100 - ◆	H805 ☒ - 100 - ◆	H806 ☒ - 100 - ◆					
	10 - 150	50 - 560	H804 ☒ - 150 - ◆	H805 ☒ - 150 - ◆	H806 ☒ - 150 - ◆					
1½" SAE 24	3 - 30	10 - 110	H854 ☒ - 030 - ◆	H855 ☒ - 030 - ◆	H856 ☒ - 030 - ◆	B	5000 psi S	F1/F2		MR
	5 - 50	20 - 190	H854 ☒ - 050 - ◆	H855 ☒ - 050 - ◆	H856 ☒ - 050 - ◆					
	10 - 75	40 - 280	H854 ☒ - 075 - ◆	H855 ☒ - 075 - ◆	H856 ☒ - 075 - ◆					
	10 - 100	50 - 380	H854 ☒ - 100 - ◆	H855 ☒ - 100 - ◆	H856 ☒ - 100 - ◆					
	10 - 150	50 - 560	H854 ☒ - 150 - ◆	H855 ☒ - 150 - ◆	H856 ☒ - 150 - ◆					

① Fractional sizes apply to NPTF and BSPF.

Example: H 705 B - 030 - F1 or F2

Flow-Alert flow switches
 F1 = Single switch
 F2 = Double switch

Example: H 701 A - 030 - RS1NO

Flow-Alert reed switches
Options:
 RS1NO (reed switch one (1) normally open)
 RS2NO (reed switch two (2) normally open)
 RS1NC (reed switch one (1) normally closed)
 RS2NC (reed switch two (2) normally closed)
Note: ¼" liquid meters for .02-0.2 and .05-0.5 GPM ranges available in strap-on design for RS1NO and RS1NC only.

Example: H 705 B - 030 - MR

Multiple output flow sensor
 3 standard field selectable outputs
 0-5 VDC } Flow transmitter is factory-calibrated to provide 4 mA (0 VDC) at zero flow and 20 mA (5/10 VDC) at full flow. Optional 5-point calibration certificate available
 0-10 VDC }
 4-20 mA }

Flow-Alert flow switches and flow transmitters

For API oil / Caustic and corrosive liquids

Ordering information

Nominal port size	Flow range		Model number (see example below)				Options ♦		
	gal/min	l/min	API - oil .876 (S.G.)		Liquids 1.0 (S.G.)		Flow-Alert 1 switch / 2 switch	Flow-Alert reed switch	Multiple output sensor
			NPTF	BSPP	NPSF	BSPP			
¼"	0.1 - 1.0	0.5 - 3.75	6000 psi	6000 psi	6000 psi	6000 psi	Not available		Not available
			H231X - 010 - ♦	H232X - 010 - ♦	H234X - 010 - ♦	H235X - 010 - ♦			
¼"	0.2 - 2.0	1 - 7.5	6000 psi	6000 psi	6000 psi	6000 psi	F1/F2		MR
			H231X - 020 - ♦	H232X - 020 - ♦	H234X - 020 - ♦	H235X - 020 - ♦			
½"	0.2 - 2.0	1 - 7.5	6000 psi	6000 psi	6000 psi	6000 psi	F1/F2		MR
			H631X - 002 - ♦	H632X - 002 - ♦	H634X - 002 - ♦	H635X - 002 - ♦			
			H631X - 005 - ♦	H632X - 005 - ♦	H634X - 005 - ♦	H635X - 005 - ♦			
			H631X - 010 - ♦	H632X - 010 - ♦	H634X - 010 - ♦	H635X - 010 - ♦			
¾"	0.2 - 2.0	1 - 7.5	5000 psi	5000 psi	5000 psi	5000 psi	F1/F2	See	MR
			H731X - 002 - ♦	H732X - 002 - ♦	H734X - 002 - ♦	H735X - 002 - ♦			
			H731X - 005 - ♦	H732X - 005 - ♦	H734X - 005 - ♦	H735X - 005 - ♦			
			H731X - 010 - ♦	H732X - 010 - ♦	H734X - 010 - ♦	H735X - 010 - ♦			
1"	0.2 - 2.0	1 - 7.5	5000 psi	5000 psi	5000 psi	5000 psi	F1/F2	options below	MR
			H741X - 002 - ♦	H742X - 002 - ♦	H744X - 002 - ♦	H745X - 002 - ♦			
			H741X - 005 - ♦	H742X - 005 - ♦	H744X - 005 - ♦	H745X - 005 - ♦			
			H741X - 010 - ♦	H742X - 010 - ♦	H744X - 010 - ♦	H745X - 010 - ♦			
1¼"	3 - 30	10 - 110	5000 psi	5000 psi	5000 psi	5000 psi	F1/F2		MR
			H831X - 030 - ♦	H832X - 030 - ♦	H834X - 030 - ♦	H835X - 030 - ♦			
			H831X - 050 - ♦	H832X - 050 - ♦	H834X - 050 - ♦	H835X - 050 - ♦			
			H831X - 075 - ♦	H832X - 075 - ♦	H834X - 075 - ♦	H835X - 075 - ♦			
1½"	3 - 30	10 - 110	5000 psi	5000 psi	5000 psi	5000 psi	F1/F2		MR
			H841X - 030 - ♦	H842X - 030 - ♦	H844X - 030 - ♦	H845X - 030 - ♦			
			H841X - 050 - ♦	H842X - 050 - ♦	H844X - 050 - ♦	H845X - 050 - ♦			
			H841X - 075 - ♦	H842X - 075 - ♦	H844X - 075 - ♦	H845X - 075 - ♦			

Example: H 734 X - 030 - F1 or F2



Flow-Alert flow switches

F1 = Single switch
F2 = Double switch



Example: H 734 X - 030 - RS1NO

Flow-Alert reed switches

Options:

- RS1NO (reed switch one (1) normally open)
- RS2NO (reed switch two (2) normally open)
- RS1NC (reed switch one (1) normally closed)
- RS2NC (reed switch two (2) normally closed)

Note: ¼" liquid meters for 0.1-1.0 gal/min range available in strap-on For detailed flow/pressure drop charts, see page 62.



Example: H 734 X - 030 - MR

Multiple output flow sensor

3 standard field selectable outputs
0-5 VDC } Flow transmitter is factory-calibrated to provide 4 mA
0-10 VDC } (0 VDC) at zero flow and 20 mA (5/10 VDC) at full flow.
4-20 mA } Optional 5-point calibration certificate available

Flow-Alert flow switches and flow transmitters

For air / Caustic and corrosive gases

Ordering information

Nominal port size	Flow range		Model number (see example below)		Options ♦		
	SCFM	l/sec	Gases 1.0 (S.G.)		Flow-Alert 1 switch / 2 switch	Flow-Alert reed switch	Multiple output sensor
			NPTF	BSP			
¼"	2.0 - 20	1 - 9	H237X - 020 - ♦	H238X - 020 - ♦	Not available		Not available
	3.0 - 30	1.5 - 14	H237X - 030 - ♦	H238X - 030 - ♦			
¼"	3 - 25	2 - 12	H237X - 025 - ♦	H238X - 025 - ♦	F1/F2		MR
	5 - 50	3 - 22	H237X - 050 - ♦	H238X - 050 - ♦			
½"	3 - 25	2 - 12	H637X - 025 - ♦	H638X - 025 - ♦	F1/F2		MR
	5 - 50	3 - 22	H637X - 050 - ♦	H638X - 050 - ♦			
	10 - 100	5 - 47	H637X - 100 - ♦	H638X - 100 - ♦			
	15 - 150	7 - 70	H637X - 150 - ♦	H638X - 150 - ♦			
¾"	3 - 25	1.5 - 11.5	H737X - 025 - ♦	H738X - 025 - ♦	F1/F2	See options below	MR
	5 - 50	2 - 23	H737X - 050 - ♦	H738X - 050 - ♦			
	10 - 100	5 - 47.5	H737X - 100 - ♦	H738X - 100 - ♦			
	15 - 150	7 - 70	H737X - 150 - ♦	H738X - 150 - ♦			
1"	3 - 25	1.5 - 11.5	H747X - 025 - ♦	H748X - 025 - ♦	F1/F2		MR
	5 - 50	2 - 23	H747X - 050 - ♦	H748X - 050 - ♦			
	10 - 100	5 - 47.5	H747X - 100 - ♦	H748X - 100 - ♦			
	15 - 150	7 - 70	H747X - 150 - ♦	H748X - 150 - ♦			
1 ¼"	20 - 200	10 - 95	H837X - 200 - ♦	H838X - 200 - ♦	F1/F2		MR
	40 - 400	20 - 180	H837X - 400 - ♦	H838X - 400 - ♦			
	60 - 600	30 - 280	H837X - 600 - ♦	H838X - 600 - ♦			
	80 - 800	50 - 350	H837X - 800 - ♦	H838X - 800 - ♦			
1 ½"	20 - 200	10 - 95	H847X - 200 - ♦	H848X - 200 - ♦	F1/F2		MR
	40 - 400	20 - 180	H847X - 400 - ♦	H848X - 400 - ♦			
	60 - 600	30 - 280	H847X - 600 - ♦	H848X - 600 - ♦			
	80 - 800	50 - 350	H847X - 800 - ♦	H848X - 800 - ♦			



Example: H 737 X - 250 - F1 or F2

Flow-Alert flow switches

F1 = Single switch
F2 = Double switch



Example: H 737 X - 250 - RS1NO

Flow-Alert reed switches

Options

RS1NO (reed switch one (1) normally open)
RS2NO (reed switch two (2) normally open)
RS1NC (reed switch one (1) normally closed)
RS2NC (reed switch two (2) normally closed)

Note: ¼" air meters for 2.0-20 and 3.0-30 SCFM ranges available in strap-on design for RS1NO and RS1NC only.



Example: H 737 X - 250 - MR

Multiple output flow sensor

3 standard field selectable outputs

0-5 VdV } Flow transmitter is factory-calibrated to provide 4 mA
0-10 VDC } (0 VDC) at zero flow and 20 mA (5/10 VDC) at full flow.
4-20 mA } Optional 5-point calibration certificate available.



Caution: High flow gas shock may decouple indicator.

Flow-Alert flow switches and flow transmitters

For air / Compressed gases

Ordering information

Nominal port size ①	Flow range		Model number (see example below)			Material ⌘			Options ◆		
	SCFM	l/sec	SAE	NPTF	BSPP	Aluminium 1000 psi	Brass 1000 psi	Stainless 1500 psi	Flow-Alert 1 switch / 2 switch	Flow-Alert reed switch	Multiple output sensor
¼" SAE 6	0.5 - 5	0.2 - 2.2	H270 ⌘ - 005 - ◆	H271 ⌘ - 005 - ◆	H272 ⌘ - 005 - ◆	A	B	S	Not available		Not available
	1 - 10	0.5 - 4.75	H270 ⌘ - 010 - ◆	H271 ⌘ - 010 - ◆	H272 ⌘ - 010 - ◆						
	2 - 20	1 - 9	H270 ⌘ - 020 - ◆	H271 ⌘ - 020 - ◆	H272 ⌘ - 020 - ◆						
	3 - 30	1.5 - 14	H270 ⌘ - 030 - ◆	H271 ⌘ - 030 - ◆	H272 ⌘ - 030 - ◆						
¼" SAE 6	3 - 25	2 - 12	H270 ⌘ - 025 - ◆	H271 ⌘ - 025 - ◆	H272 ⌘ - 025 - ◆	A	B	S	F1/F2		MR
	5 - 50	3 - 22	H270 ⌘ - 050 - ◆	H271 ⌘ - 050 - ◆	H272 ⌘ - 050 - ◆						
½" SAE 10	3 - 25	2 - 12	H670 ⌘ - 025 - ◆	H671 ⌘ - 025 - ◆	H672 ⌘ - 025 - ◆	A	B	S	F1/F2		MR
	5 - 50	3 - 22	H670 ⌘ - 050 - ◆	H671 ⌘ - 050 - ◆	H672 ⌘ - 050 - ◆						
	10 - 100	5 - 47	H670 ⌘ - 100 - ◆	H671 ⌘ - 100 - ◆	H672 ⌘ - 100 - ◆						
	15 - 150	7 - 70	H670 ⌘ - 150 - ◆	H671 ⌘ - 150 - ◆	H672 ⌘ - 150 - ◆						
¾" SAE 12	3 - 25	1.5 - 11.5	H770 ⌘ - 025 - ◆	H771 ⌘ - 025 - ◆	H772 ⌘ - 025 - ◆	A	B	S	F1/F2	See options below	MR
	5 - 50	2 - 23	H770 ⌘ - 050 - ◆	H771 ⌘ - 050 - ◆	H772 ⌘ - 050 - ◆						
	10 - 100	5 - 47.5	H770 ⌘ - 100 - ◆	H771 ⌘ - 100 - ◆	H772 ⌘ - 100 - ◆						
	15 - 150	7 - 70	H770 ⌘ - 150 - ◆	H771 ⌘ - 150 - ◆	H772 ⌘ - 150 - ◆						
	25 - 250	10 - 118	H770 ⌘ - 250 - ◆	H771 ⌘ - 250 - ◆	H772 ⌘ - 250 - ◆						
1" SAE 16	3 - 25	1.5 - 11.5	H790 ⌘ - 025 - ◆	H791 ⌘ - 025 - ◆	H792 ⌘ - 025 - ◆	A	B	S	F1/F2	See options below	MR
	5 - 50	2 - 23	H790 ⌘ - 050 - ◆	H791 ⌘ - 050 - ◆	H792 ⌘ - 050 - ◆						
	10 - 100	5 - 47.5	H790 ⌘ - 100 - ◆	H791 ⌘ - 100 - ◆	H792 ⌘ - 100 - ◆						
	15 - 150	7 - 70	H790 ⌘ - 150 - ◆	H791 ⌘ - 150 - ◆	H792 ⌘ - 150 - ◆						
	25 - 250	10 - 118	H790 ⌘ - 250 - ◆	H791 ⌘ - 250 - ◆	H792 ⌘ - 250 - ◆						
1¼" SAE 20	20 - 200	10 - 95	H870 ⌘ - 200 - ◆	H871 ⌘ - 200 - ◆	H872 ⌘ - 200 - ◆	A	B	S	F1/F2		MR
	40 - 400	20 - 180	H870 ⌘ - 400 - ◆	H871 ⌘ - 400 - ◆	H872 ⌘ - 400 - ◆						
	60 - 600	30 - 280	H870 ⌘ - 600 - ◆	H871 ⌘ - 600 - ◆	H872 ⌘ - 600 - ◆						
	80 - 800	50 - 350	H870 ⌘ - 800 - ◆	H871 ⌘ - 800 - ◆	H872 ⌘ - 800 - ◆						
	100 - 1000	50 - 475	H870 ⌘ - 999 - ◆	H871 ⌘ - 999 - ◆	H872 ⌘ - 999 - ◆						
1½" SAE 24	20 - 200	10 - 95	H890 ⌘ - 200 - ◆	H891 ⌘ - 200 - ◆	H892 ⌘ - 200 - ◆	A	B	S	F1/F2		MR
	40 - 400	20 - 180	H890 ⌘ - 400 - ◆	H891 ⌘ - 400 - ◆	H892 ⌘ - 400 - ◆						
	60 - 600	30 - 280	H890 ⌘ - 600 - ◆	H891 ⌘ - 600 - ◆	H892 ⌘ - 600 - ◆						
	80 - 800	50 - 350	H890 ⌘ - 800 - ◆	H891 ⌘ - 800 - ◆	H892 ⌘ - 800 - ◆						
	100 - 1000	50 - 475	H890 ⌘ - 999 - ◆	H891 ⌘ - 999 - ◆	H892 ⌘ - 999 - ◆						

① Fractional sizes apply to NPTF and BSPP.



Example: H 771 A - 250 - F1 or F2

Flow-Alert flow switches
F1 = Single switch
F2 = Double switch



Example: H 701 A - 030

Flow-Alert reed switches
Options
RS1NO (reedswitch one (1) normally open)
RS2NO (reedswitch two (2) normally open)
RS1NC (reedswitch one (1) normally closed)
RS2NC (reedswitch two (2) normally closed)
NOTE: ¼" air meters for .05-5, 1-10, 2-20 and 3-30 SCFM ranges available in strap-on design for RS1NO and RS1NC only.



Example: H 771 A - 250 - MR

Multiple output flow sensor
3 standard field selectable outputs
0-5 VDC } Flow transmitter is factory-calibrated to provide 4 mA (0 VDC)
0-10 VDC } at zero flow and 20 mA (5/10 VDC) at full flow. Optional 5-point
4-20 mA } calibration certificate available



Caution: High flow gas shock may decouple indicator.

Digital display

For Hedland® MR flow transmitters

Applications

- Remote flow meter monitoring
- Totalizing
- Alarm processing
- Process control

Features

- 5-digit rate display
- 5-digit totalizer with 4-digit overcarry
- Input, 4-20 mA or 0-10 VDC
- Built-in transmitter power supply
- Three plug-in card slots
- Optional setpoint alarm cards
- AC and DC powered versions
- NEMA 4X/IP65 rated



Introduction

The F6700/F6750 series digital display with integrated signal processor accepts a 4-20 mA or 0-10 VDC signal from Hedland's MR flow transmitters as well as any other 4-20 mA or 0-10 VDC source. These 5-digit displays can be scaled to most engineering units and are easily programmed using the front panel buttons or available programming software. To meet your specific requirements, each display accepts up to three optional plug-in cards. One card for each of the following function types can be installed in each display:

Analog outputs

A linear DC output signal card will be set up to provide either 4-20 mA, 0-20 mA or 0-10 VDC signals and can be scaled independent of the input range.

Communications

Optional plug-in cards to facilitate digital communications include: RS232, RS485, ModBus®, Profibus and DeviceNet.

Setpoint alarms

Select from dual FORM-C relays (5 Amp), quad FORM-A relays (3 Amp) or either sinking or sourcing quad open collector logic outputs.

The analog output and communication cards will be installed by the factory at time of order, or they may be installed by the customer at a later date. The setpoint alarm cards are available for customer installation and setup only.

Technical data

Display	5-digit, 0.56" sunlight-readable red LED
Power	
AC	85 to 250 VAC, 50/60 Hz, 15 VA
DC	11 to 36 VDC, 11 W
A/D converter	16-bit resolution
A/D conversion rate	20 readings/sec
Display update rate	1 to 20 updates/sec
Sensor inputs	4-20 mA or 0-10 VDC
Transmitter power	24 VDC, ±5%, regulated 50 mA maximum
Totalizer time base	Second, minute, hour or day
Total	9 digits, display alternates between high order and low order readouts
Linearization data	
Point pairs	Selectable from 2 to 16
Operating temperature	0 °C to 50 °C (32 °F to 122 °F) 0 °C to 45 °C (32 °F to 113 °F with all three plug-in cards installed)

Digital display

For Hedland® MR flow transmitters

Ordering example

F6700-X-X-G	AC powered, displays GPM
F6700-A-A-L	AC powered + 4-20 mA Out + RS232, displays LPM
F6750-C-X-S	DC powered + 0-10 VDC Out, displays SCFM

Ordering information

Power version	Display	Analog output	Communications		Display units	
AC	F6700	4-20 mA - A	RS232	- A	GPM	- G
DC	F6750	0-20 mA - B	RS485	- B	LPM	- L
		0-10 VDC - C	Modbus	- C	SCFM	- S
		None - X	Profibus	- D	LPS	- T
			DeviceNet	- E		
			None	- X		

Note: Select one option from each category

Form C relay plug-in option card

Part number F6542

This optional plug-in card requires customer installation and setup. To facilitate setup, it is recommended that this feature be utilized with a display that includes a serial communication card (RS232 or RS485) and programming software.

Note: For additional setpoint alarm options, consult factory for information.

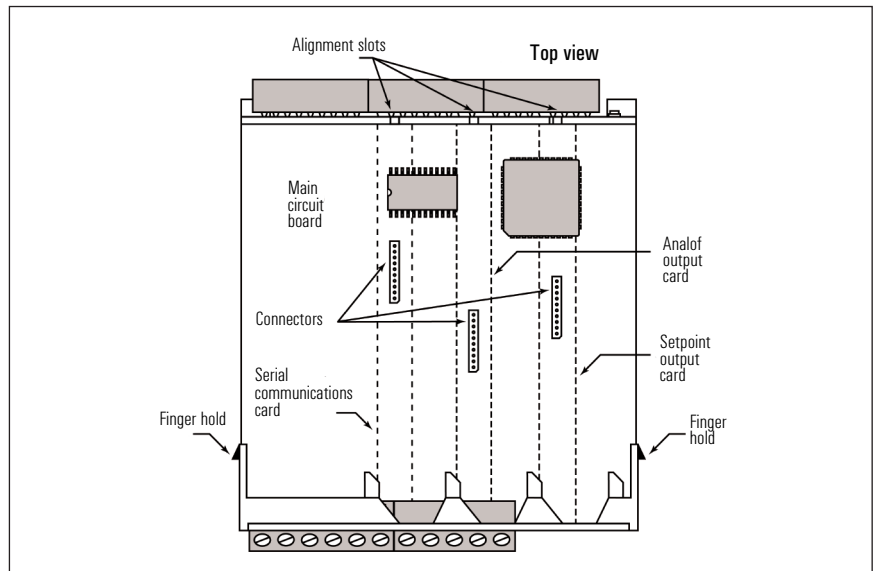

Dimensions

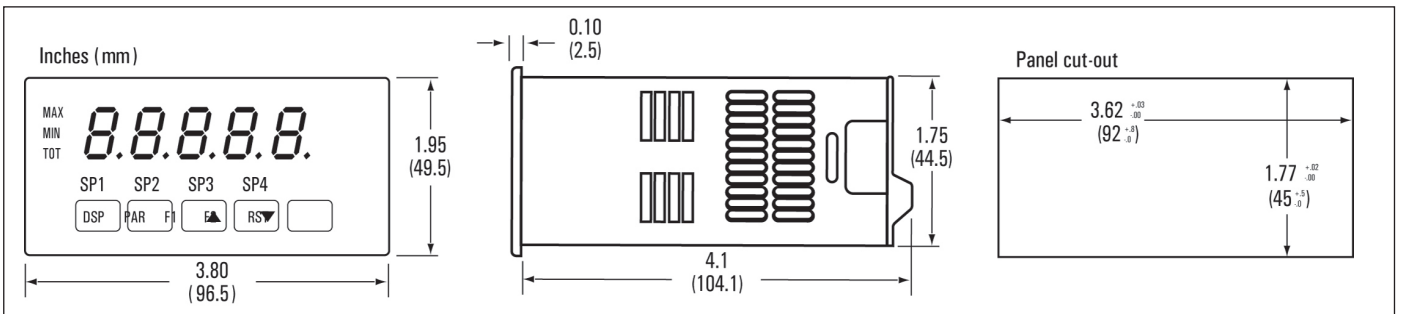

Flow vs. Pressure drop

Petroleum fluids

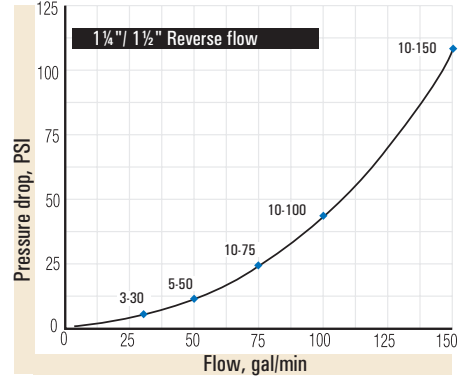
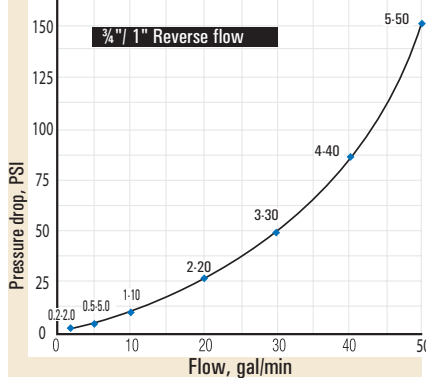
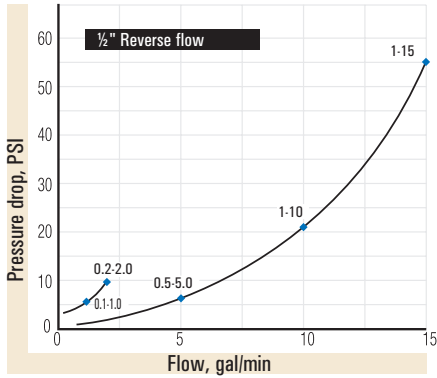
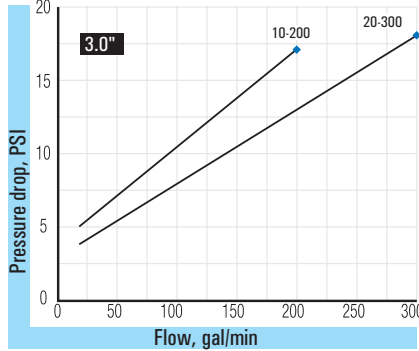
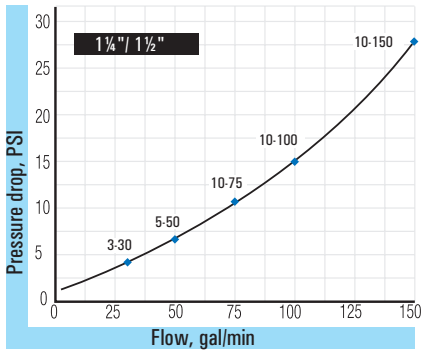
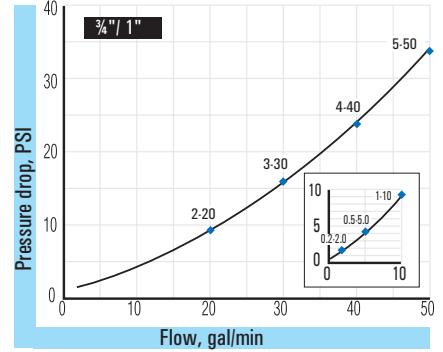
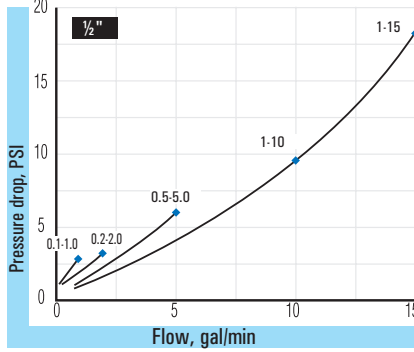
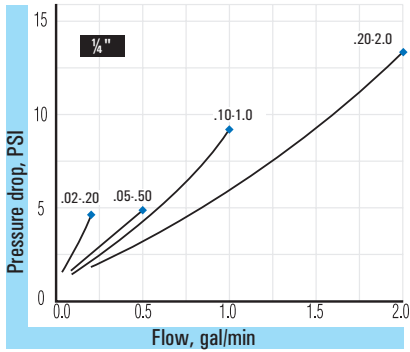

Petroleum test kits

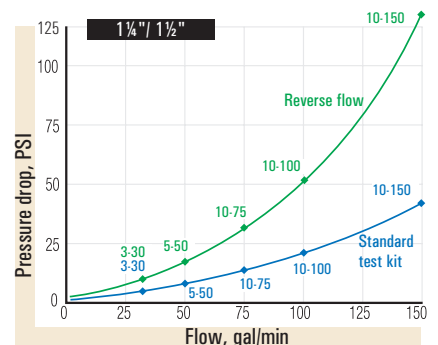
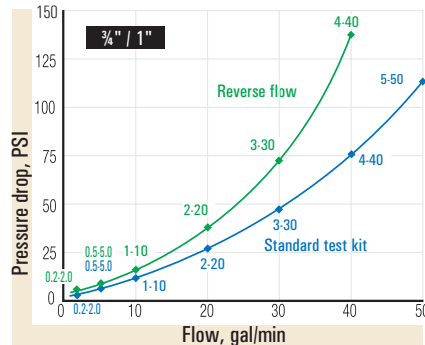
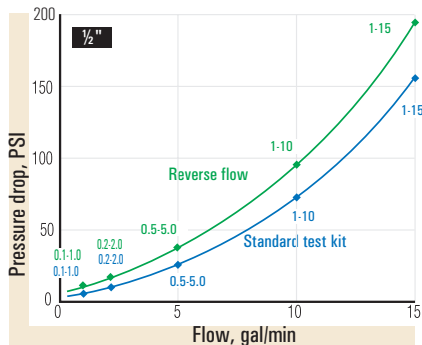

Flow vs. Pressure drop

Phosphate ester

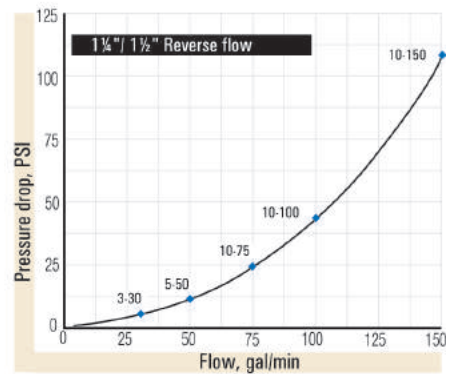
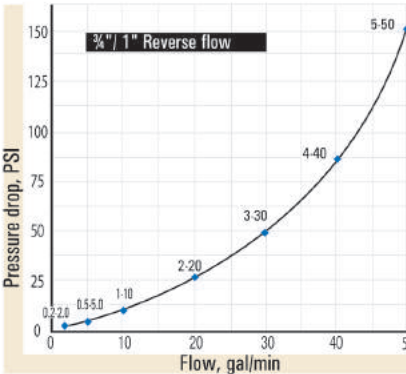
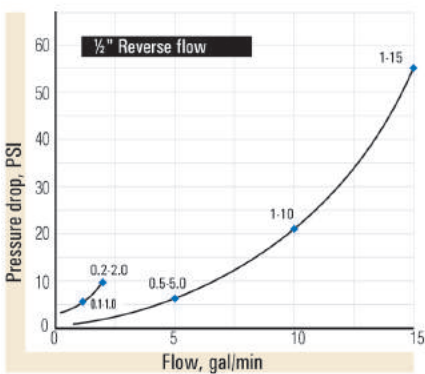
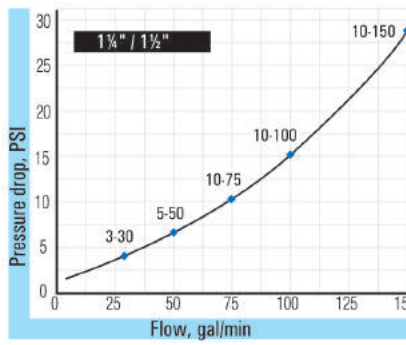
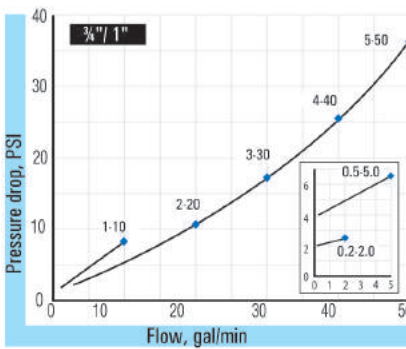
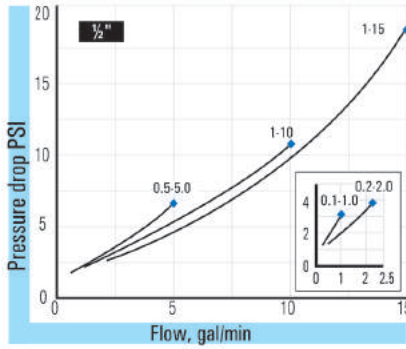
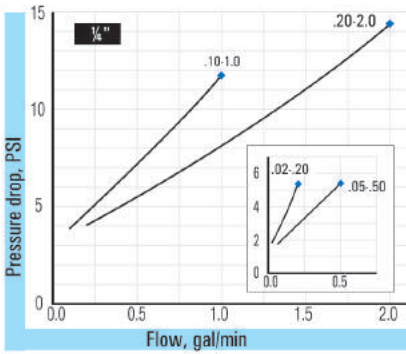

Phosphate ester test kits

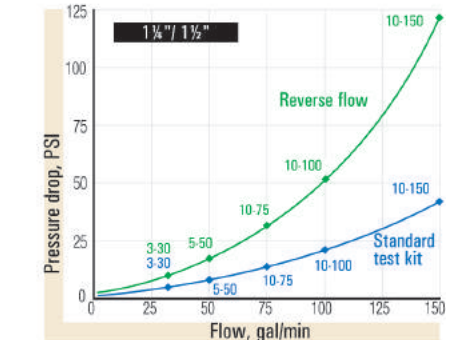
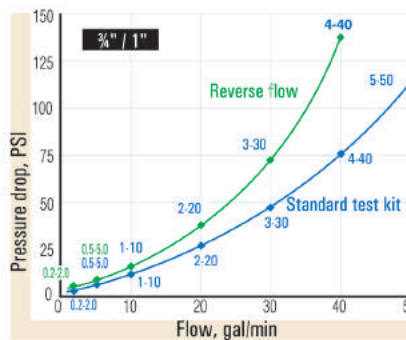
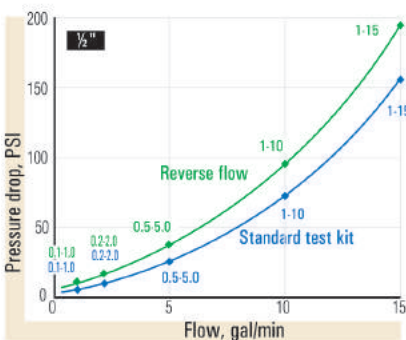

Flow vs. Pressure drop

Water-based fluids

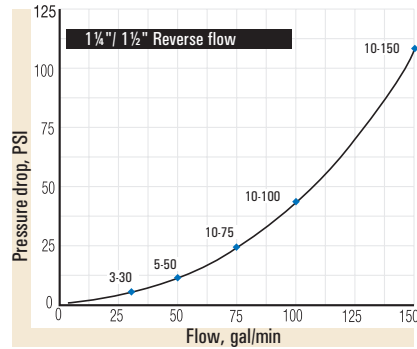
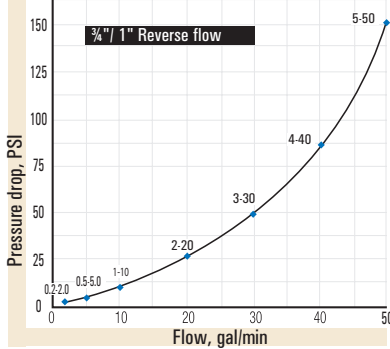
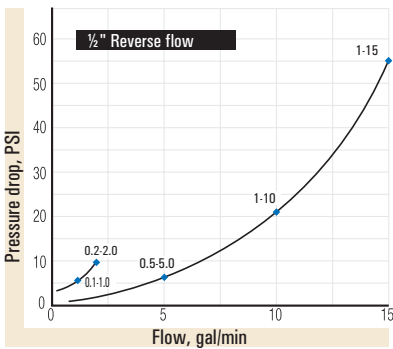
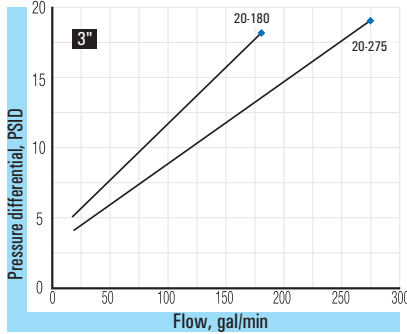
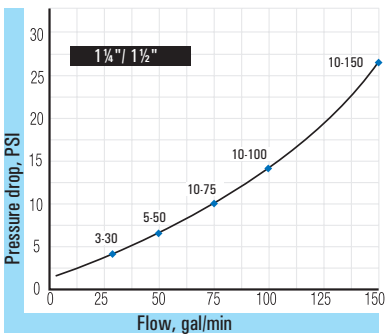
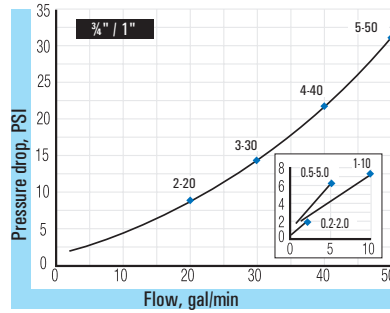
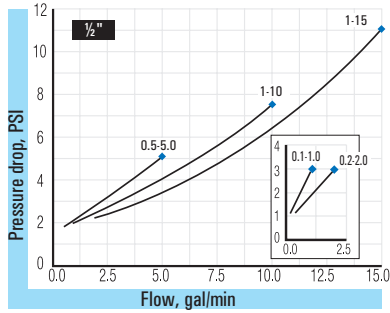
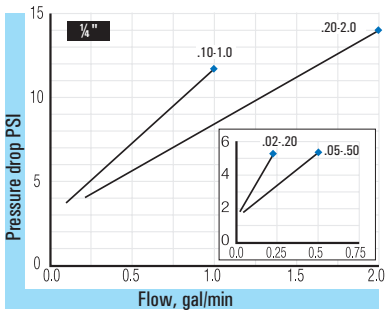

Water-based fluid test kits

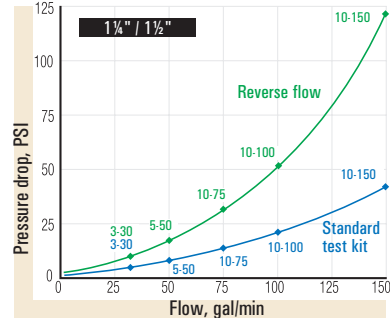
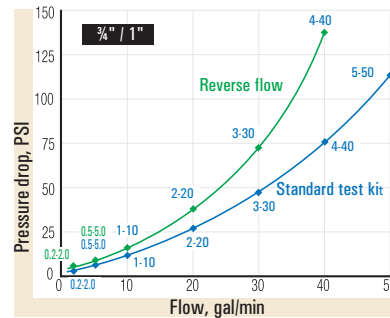
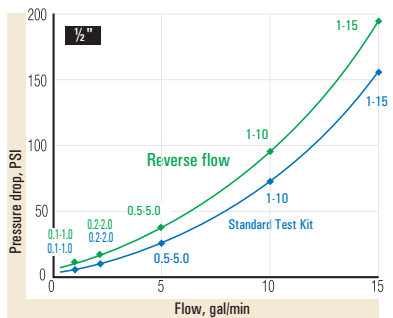

Flow vs. Pressure drop

Water

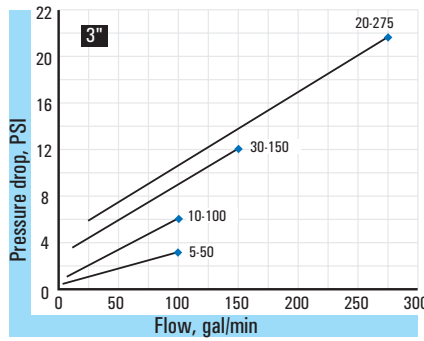
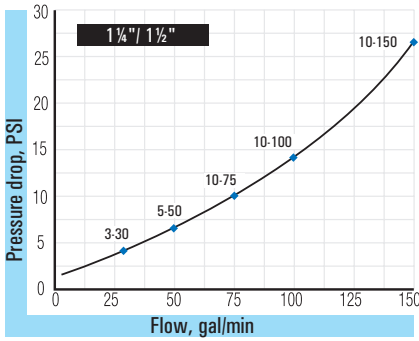
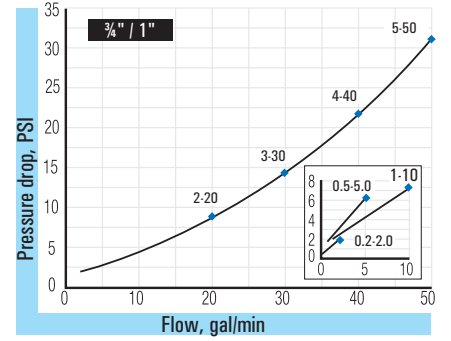
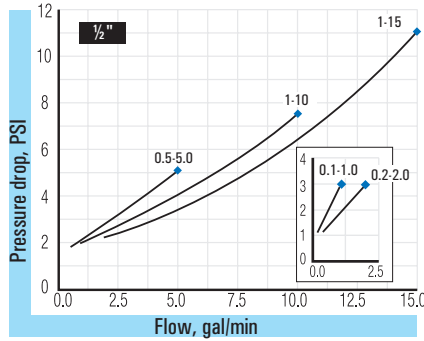
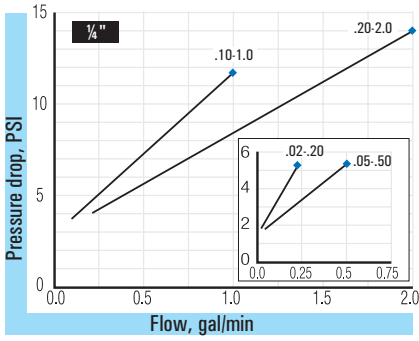

Caustic and corrosive liquids

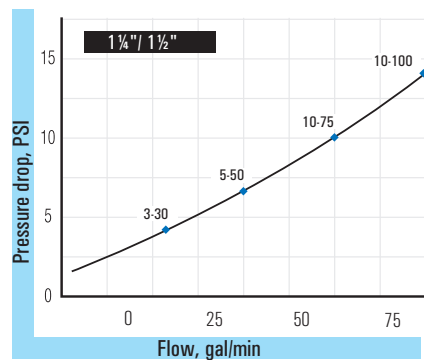
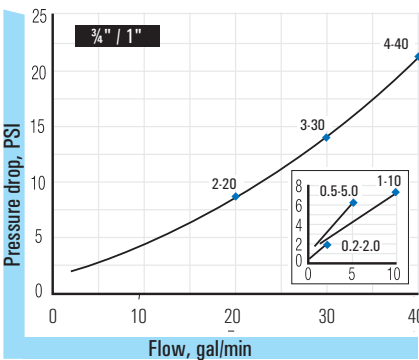
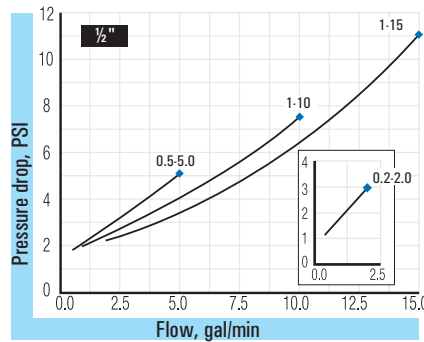
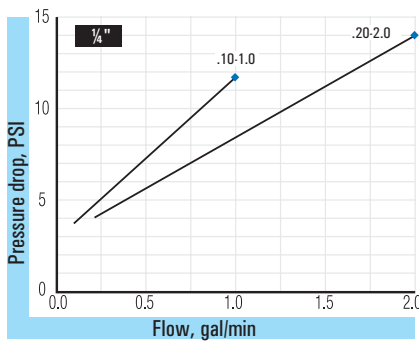

150

Flow vs. Pressure drop

A.P.I. oil

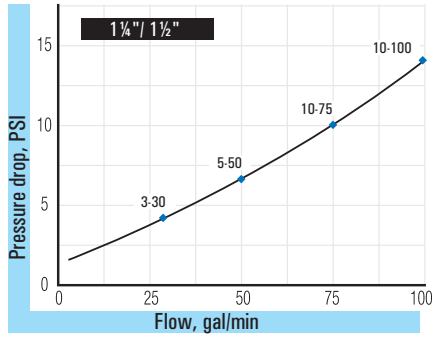
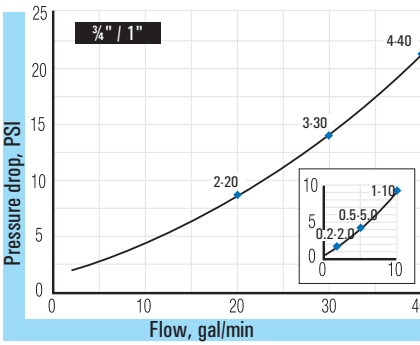
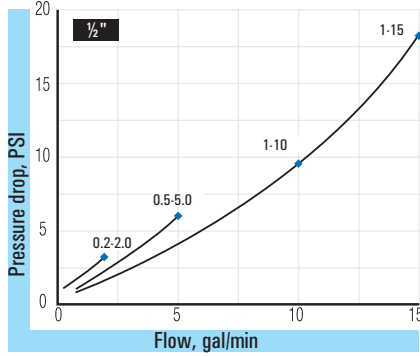
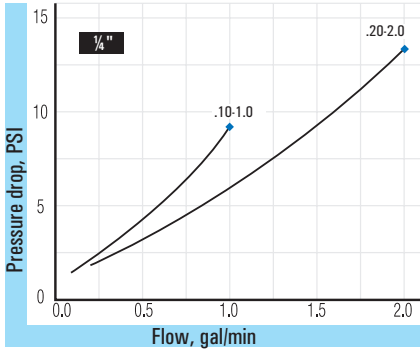

Air, caustic and corrosive gases

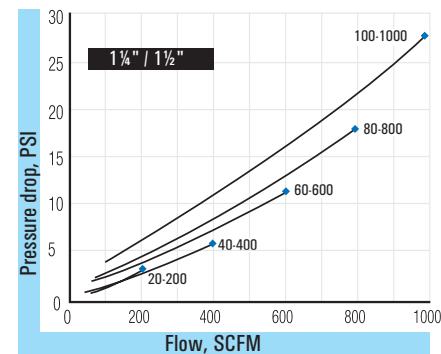
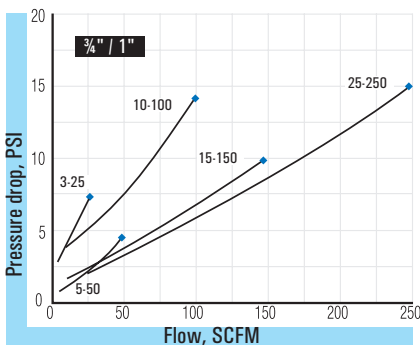
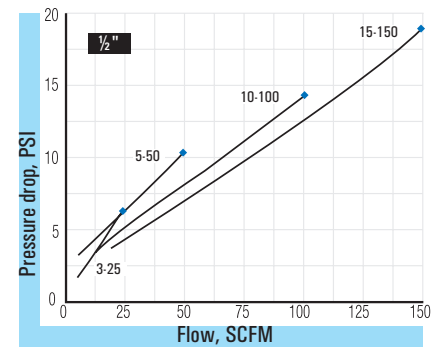
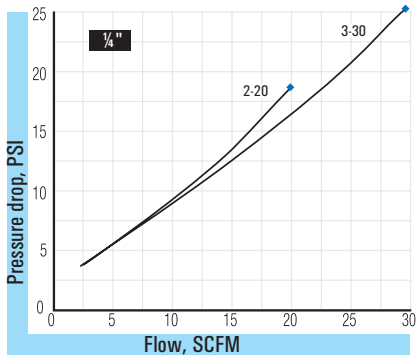

Flow vs. Pressure drop

Air and compressed gases

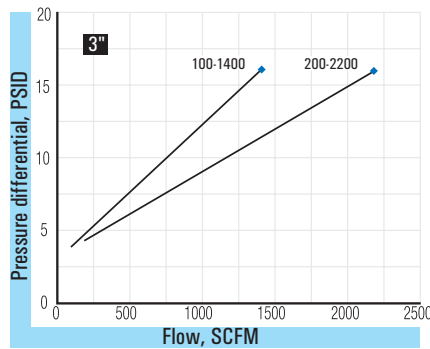
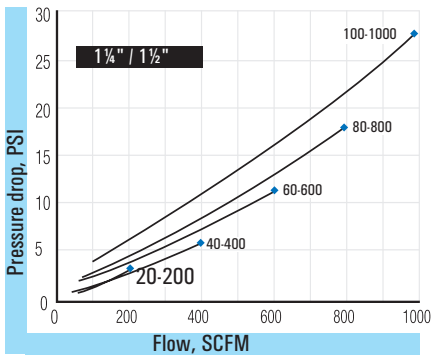
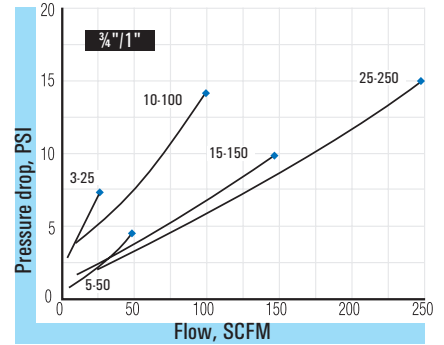
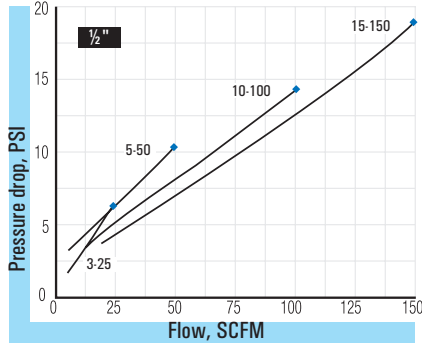
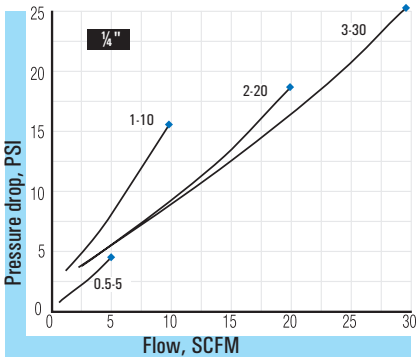

Air and compressed gas test kits

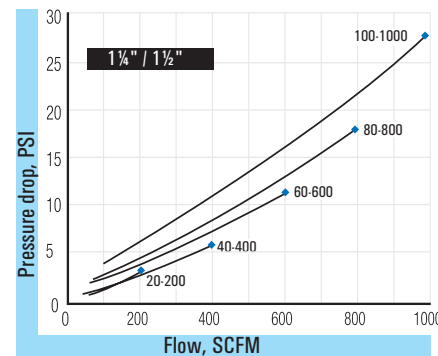
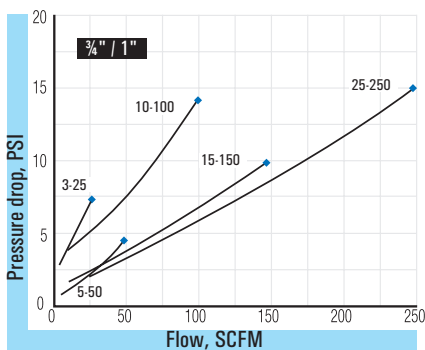
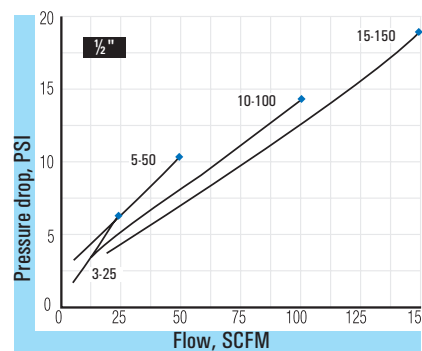
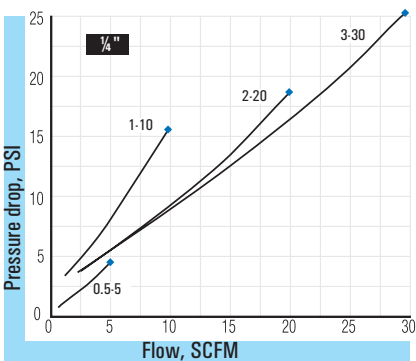

EZ-View[®] flow meters

General design features

Operating principle

The EZ-View[®] flow meter is a variable area instrument. A precision molded, sharp-edged orifice^① located within the piston assembly^②, forms an annular opening with the metering cone^③. Flow through the meter creates a pressure differential across the sharp-edged orifice, moving the piston against the spring^④. The piston moves precisely, in direct proportion to the rate of flow. The calibrated spring opposes flow in the forward direction. This spring decreases viscosity sensitivity and allows the flow meters to be used in any position, including inverted. The indicated flow rate is measured by viewing the red flow indicator^⑤ line on the piston relative to the precalibrated numerical scale, mounted on the outer surface of the transparent flow meter body.

Note: The piston assembly carries a cylindrical magnet on all EZ-View[®] Flow-Alert models. This magnet is necessary to activate the AC, DC or reed switch modules when flow conditions are too high or too low.

Operates in any position

The in-line flow meter's unique spring loaded variable area design allows meters to be installed in any position without effecting accuracy. It can be installed into horizontal or vertical lines, or with an optional inverted flow scale, this meter can monitor flow in a downward flowing (i.e. gravity feed) line.

Easy-to-read scale

This flow meter is the most readable product in its class. A brightly colored flow scale^⑥ contains bold, easy-to-read numerals and gauge marks. This enhanced resolution virtually eliminates parallax problems associated with competitive, direct reading flow meters.

Accuracy within ±5% full scale

The EZ-View[®] flow meter accuracy is within ±5% of full scale while monitoring liquids with viscosity and specific gravity similar to factory calibrated fluids.

Repeatability

This is particularly important in cyclical applications, which require consistent readings.

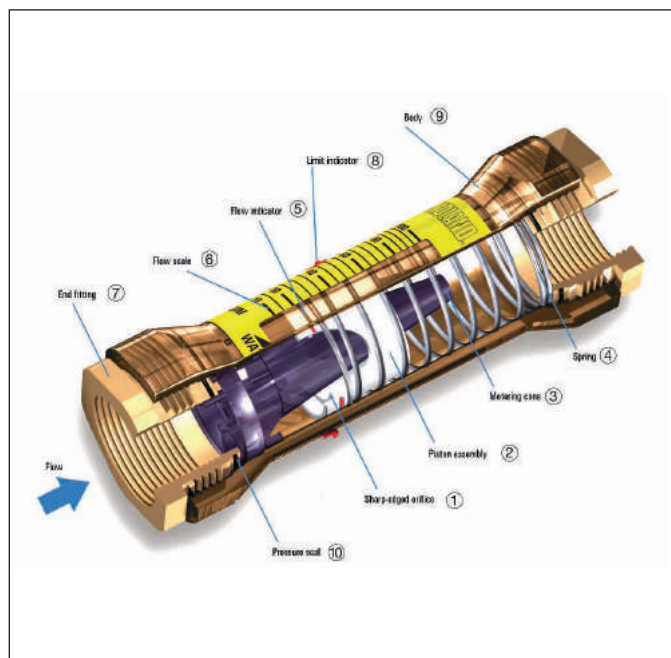

Operating temperature

Maximum operating temperature is 121 °C (250 °F).

Operating pressure

Maximum operating pressure is 325 psi/22.4 bar.

Rugged construction

Flow meters are available in brass, stainless, and PVC fittings, with NPT or BSP ports (see ordering information tables). Constructed of high-impact polysulfone plastic, this simple variable area flow meter contains a minimum number of moving parts, offering a reliable, trouble-free flow rate indicator to monitor a wide range of liquids and gases.

Note: Inlet and outlet

EZ-View[®] flow meters

General design features

No flow straighteners or special piping

The design does not require special plumbing or accessories to stabilize turbulent flow. Flow meters can be installed immediately adjacent to 90-degree elbows or other components providing system design flexibility.

Filtration

The flow meters are more contamination tolerant than most fluid system components, 200 mesh (74 micron) or better filtration is required to assure reliable performance.

Standard flow scales

Standard flow scales are calibrated in gallons per minute (gpm) and liters per minute (lpm) at 0.876 specific gravity for petroleum-based fluids, 1.0 specific gravity for water and water-based emulsions.

Special flow scales

Special scales are available in any measurement unit and/or specific gravity.

Viscosity effect (SUS/cSt)

The design utilizes a precision-molded, sharp-edged orifice and biasing calibration spring that ensures operating stability and accuracy over the wide viscosity range common to many fluids. Generally, high flow models provide good accuracy over a viscosity range of 40 to 500 SUS (4.2 to 108 cSt).

Density effect (specific gravity)

Any fluid density change from stated standards has a square-root effect on meter accuracy. Special scales can be supplied if actual specific gravity decreases accuracy beyond application limits.

Corrections for more or less dense fluids can be made to standard scales using correction equations. Refer to pages 5-7.

Fluid selection chart

Fluid	Specific gravity	Correction factor of standard scale		Internal components				Fittings		
		Oil	Water	Polysulfone	T300 stainless spring	Buna N	PH15 7 MO stainless retaining ring	C360 brass	PVC - type 1	T303 stainless
Acetic acid (air free)	1.06	0.909	0.971	R	R	C	R	N	R	R
Acetone	0.79	1.053	1.125	N	R	N	R	R	N	R
Alcohol butyl (Butanol)	0.83	1.027	1.098	R	R	R	R	C	R	R
Alcohol ethyl (Ethanol)	0.83	1.027	1.098	R	R	N	R	C	R	R
Ammonia	0.89	0.992	1.060	R	R	C	R	C	R	R
Benzene	0.69	1.127	1.204	N	N	N	N	R	N	N
Carbon disulphide	1.26	0.834	0.891	N	R	N	R	N	N	R
Castor oil	0.97	0.950	1.015	C	C	R	C	R	C	C
Cotton seed oil	0.93	0.970	1.037	R	R	R	R	R	N	R
Ethylene glycol 50/50	1.12	0.884	0.945	R	R	R	R	R	R	R
Freon II	1.46	0.774	0.828	N	R	N	R	R	N	R
Gasoline	0.70	1.119	1.195	R	R	R	R	R	C	R
Glycerin	1.26	0.834	0.891	R	R	R	R	R	R	R
Kerosene	0.82	1.033	1.104	R	R	R	R	R	R	R
Liquid propane (LPG)	0.51	1.310	1.400	N	R	R	R	R	R	R
Mineral oil	0.92	0.976	1.042	R	R	R	R	R	R	R
Naphtha	0.76	1.074	1.147	N	R	R	R	N	N	R
Perchloroethylene	1.62	0.735	0.786	N	R	R	R	N	N	R
Petroleum oil	0.876	1.000	1.068	R	R	R	R	R	R	R
Phosphate ester	1.18	0.862	0.921	N	R	N	R	R	N	R
Phosphate ester base	1.26	0.833	0.891	N	R	N	R	R	N	R
Phosphoric acid (air free)	1.78	0.701	0.749	R	N	C	N	N	R	N
Sea water	1.03	0.922	0.985	R	N	R	N	N	R	N
Synthetic petroleum base	1.00	0.936	1.000	R	R	R	R	C	R	R
Water	1.00	0.936	1.000	R	R	R	R	R	R	R
Water glycol 50/50	1.07	0.905	0.967	R	R	R	R	R	R	R
Water-in-oil	0.93	0.970	1.037	R	R	R	R	R	R	R

R – Recommended N – Not recommended C – Consult factory

EZ-View[®] flow meters

For oil and water

- ½ to 1 inch ports
- EZ to install, in any position
- Polysulfone bodies for standard applications or Radel[®] R for more aggressive media
- No special piping or flow straighteners needed
- No electrical connections
- Direct reading indication
- Accuracy within 5% full scale
- Relatively insensitive to shock and vibration



EZ-View[®] with Polysulfone body



EZ-View[®] with Radel[®] R body

Technical data

Materials	Polysulfone plastic body, piston and cone Radel [®] R plastic body and cone, polysulfone piston
Common parts	
Spring	T300-series stainless
Indicator ring	Buna N
Pressure seals	Buna N
Fittings	C360 brass, PVC, or T303 stainless steel
Limit indicator	Polypropylene
Retaining ring	PH15 – 7MO stainless
Optional (consult factory)	Spring + retaining ring: Teflon [®] coated
Fittings/ threads	NPT ANSI/ASME B1.20.1, BSPT ISOR7 See ordering information table next page.
Temperature range	0 °C to +121 °C (+32 °F to +250 °F)
Pressure rating	325 psi / 22.4 bar maximum
Pressure drop	See differential pressure charts.
Accuracy	±5% of full scale
Repeatability	±1%
Dimensions	See ordering information table next page.

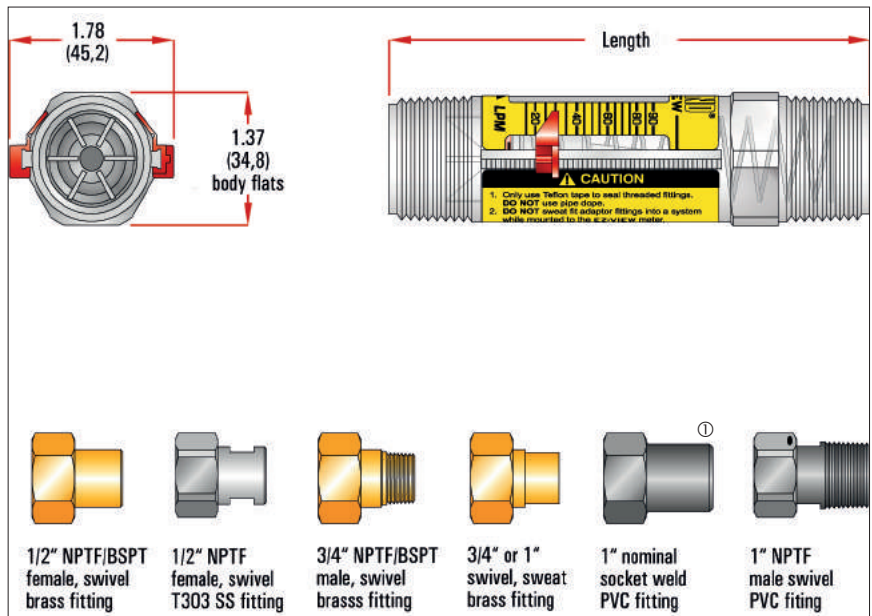

① Meters with type 1 PVC fittings: Pressure rating psi normal PVC system specification.
Temperature range 0 °C to +60 °C (+32 °F to +140 °F)

EZ-View[®] flow meters

For oil and water

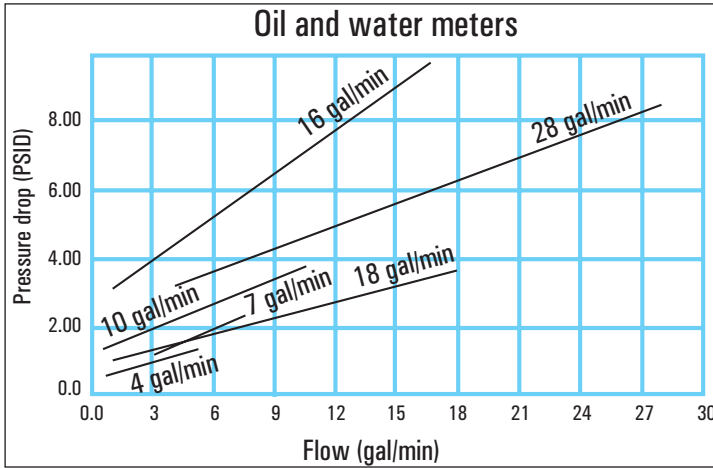

Ordering information

Fluid media	Flow range		½" NPTF female, swivel brass fitting	½" NPTF female, swivel T303 SS fitting	½" BSPT female, swivel brass fitting	¾" NPTF male, swivel brass fitting	¾" BSPT male, swivel brass fitting	¾" or 1" ① nominal, swivel sweat brass fitting	1" NPTF ② male, plastic polysulfone fitting	1" nominal ③ socket weld PVC fitting	1" NPTF male, swivel PVC fitting	Material	
	gal/min	l/min										Polysulfone	Radel R
Oil 0.876 s.g.	0.5 - 4	2 - 15	H624-104	H626-104	H627-104	H625-104	H630-104		H621-104	H628-104	H629-104	STD	-R
	1.0 - 7	4 - 26	H624-107	H626-107	H627-107	H625-107	H630-107		H621-107	H628-107	H629-107		
	1.0 - 10	4 - 35	H624-110	H626-110	H627-110	H625-110	H630-110		H621-110	H628-110	H629-110		
	1.0 - 16	5 - 60	H624-116	H626-116	H627-116	H625-116	H630-116		H621-116	H628-116	H629-116		
	3.0 - 18	15 - 65				H625-118	H630-118		H621-118	H628-118	H629-118		
	4.0 - 28	20 - 100				H625-128	H630-128		H621-128	H628-128	H629-128		
Water 1.0 s.g.	0.5 - 4	2 - 15	H624-004	H626-004	H627-004	H625-004	H630-004	H620-004	H621-004	H628-004	H629-004	STD	-R
	1.0 - 7	4 - 26	H624-007	H626-007	H627-007	H625-007	H630-007	H620-007	H621-007	H628-007	H629-007		
	1.0 - 10	4 - 35	H624-010	H626-010	H627-010	H625-010	H630-010	H620-010	H621-010	H628-010	H629-010		
	1.0 - 16	5 - 60	H624-016	H626-016	H627-016	H625-016	H630-016	H620-016	H621-016	H628-016	H629-016		
	3.0 - 18	15 - 65				H625-018	H630-018	H620-018	H621-018	H628-018	H629-018		
	4.0 - 28	20 - 100				H625-028	H630-028	H620-028	H621-028	H628-028	H629-028		
Dimensions	Length ④ in (mm)		7.75 (196.8)	7.75 (196.8)	7.75 (196.8)	8.25 (209.5)	8.25 (209.5)	7.75 (196.8)	5.25 (133.3)	8.46 (214.9)	8.86 (225.0)		
	Fitting flats in (mm)		1.50 (38.1)	1.50 (38.1)	1.50 (38.1)	1.50 (38.1)	1.50 (38.1)	1.50 (38.1)	N/A	1.54 (39.1)	1.50 (38.1)		
	Weight lb (kg)		0.95 (0.43)	0.85 (0.39)	0.95 (0.43)	0.90 (0.41)	0.90 (0.41)	0.75 (0.34)	0.20 (0.09)	0.35 (0.16)	0.55 (0.25)		

- ① Fits ¾" copper tube types K, L, M; 1" copper tube type M only
- ② DO NOT use pipe dope. Use Teflon[®] tape only. Use with plastic fittings only.
- ③ Fits 1" Sch 40/80 PVC, CPVC pipe. Requires 1" pipe coupling.
- ④ Length includes end fittings.

Example: Polysulfone model = H 624 - 104 Radel[®] R model = H 624 - 104-R

EZ-View[®] flow meters

With Flow-Alert flow switch

- Reeds witch and latching models
- Automatically signals alarm if flow is too high or too low
- Models available for AC or DC power supply
- Latching models include Hirschmann type electrical connector
- Polysulfone bodies for standard applications or Radel[®] R for more aggressive media
- Easy to install
- Easy flow limit adjustment
- Operates in any position
- Relatively insensitive to shock and vibration
- Repeatability within $\pm 1\%$
- Low cost

Technical data

Material	Polysulfone plastic body, piston and cone Radel [®] R plastic body and cone, polysulfone piston
Common parts	
Spring	T300-series stainless
Indicator ring	Buna N
Pressure seals	Buna N
Fittings	C360 Brass, PVC, or T303 stainless steel
Limit indicators	Polypropylene
Magnet	Strontium ferrite
Retaining ring	PH15 – 7MO stainless
Fittings/ threads	NPT ANSI/ASME B1.20.1, BSPT ISOR7 See ordering information table next page.
Temperature range	0 °C to +121 °C (+32 °F to +250 °F)
Pressure rating	325 psi / 22.4 bar maximum
Pressure drop	See differential pressure chart
Accuracy	$\pm 5\%$ of full scale
Repeatability	$\pm 1\%$
Dimensions	See ordering information table next page.

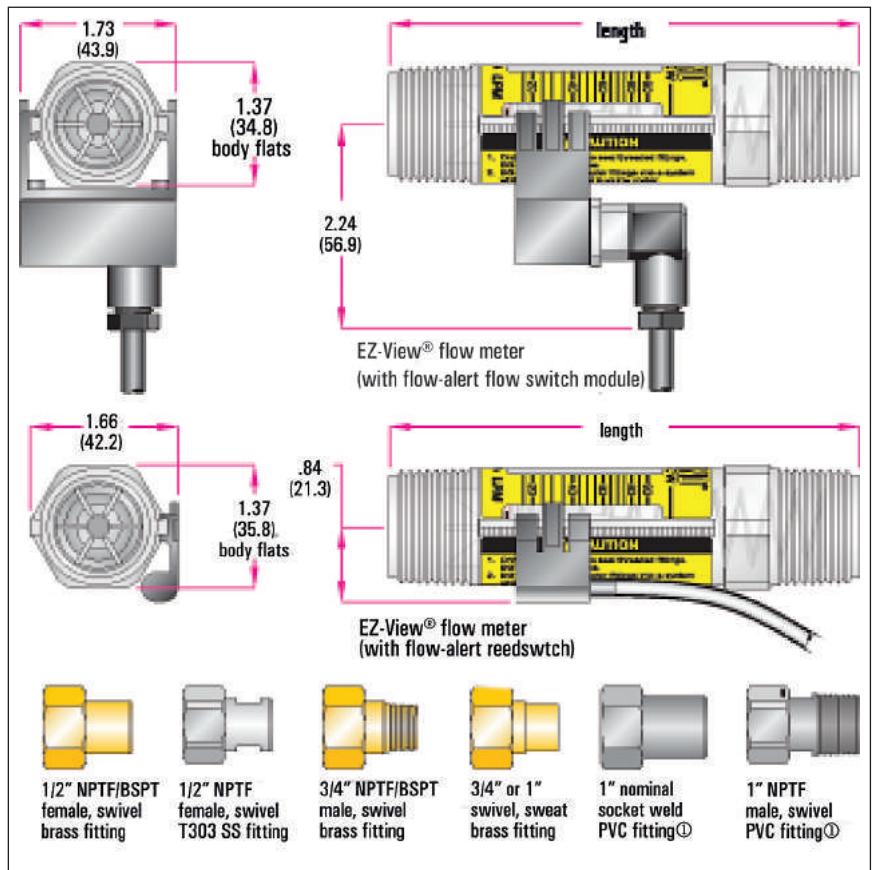
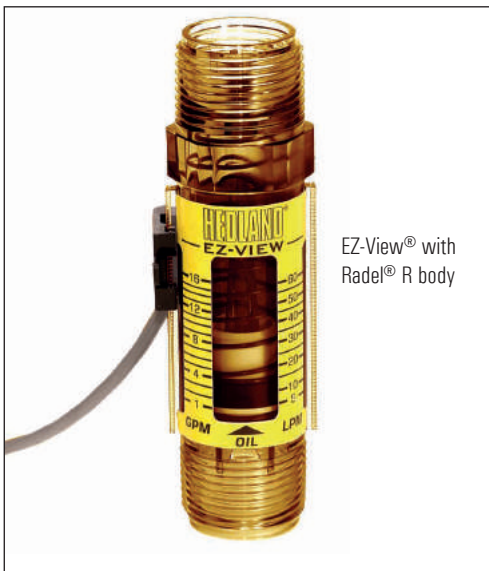

^①Meters with type 1 PVC fittings: Pressure rating per normal PVC system specifications. Temperature range 0 °C to +60 °C (+32 °F to +140°F)

EZ-View[®] flow meters

With Flow-Alert flow switch

Flow switch options and specifications:

The AC and DC powered flow-alert flow switch modules consist of a latching relay circuit housed in a sealed polypropylene enclosure. The modules have a normally open dry relay contact that can be used to directly control alarms, warning lights, relays or be used to interface to a PLC. The relay will be latched on as the magnet inside the flow meter passes by the module, and remain latched on until the magnet passes in the other direction or power is interrupted. The set point is adjustable from 0 to 100% of full scale.

The reed switch Flow-Alert modules are housed in a sealed polypropylene enclosure. The reed switch module does not provide the latching function like the AC and DC powered units. When the magnet inside the flow meter comes within proximity of the module, the reed switch will change state. The set point is adjustable from 0 to 100% full scale. Two reed switches providing low flow and high flow set points may be installed on a single flow meter.

	AC latching	DC latching	Reed switch form-A normally open (NO)	Reed switch form-B normally closed (NC)	Reed switch form-C
Operating voltage	115 VAC ±10%	10-30 VDC	-	-	-
Operating current	25 mA maximum	25 mA maximum	-	-	-
Contact rating	1A @ 30 VDC 0.5A @ 125 VAC Resistive load	1A @ 30 VDC 0.5A @ 125 VAC Resistive load	1A max 200 VDC max 15 watts max Resistive load	0.25A max 175 VDC max 5 watts max Resistive load	0.25A max 175 VDC max 5 watts max Resistive load
Operating temperature	+32 to +158 °F (0 to +70 °C)	+32 to +158 °F (0 to +70 °C)	+32 to +250 °F (0 to +121 °C)	+32 to +250 °F (0 to +121 °C)	+32 to +250 °F (0 to +121 °C)
Connector	4-pin connector (protection class IP65)	4-pin connector (protection class IP65)	-	-	-
Cable	Not included	Not included	3 foot, 2-wire #24 AWG black PVC Jacketed pig-tail	3 foot, 2-wire #20 AWG grey PVC Jacketed pig-tail	3 foot, 3-wire #24 AWG grey PVC Jacketed pig-tail
Rating	NEMA 12 & 13 (IP65)	NEMA 12 & 13 (IP65)	NEMA 12 & 13 (IP65)	NEMA 12 & 13 (IP65)	NEMA 12 & 13 (IP65)
Certification	N/A	EMC directive 89/336/EEC	EMC directive 89/336/EEC	EMC directive 89/336/EEC	EMC directive 89/336/EEC
Model number	H526-003	H526-005	H526-008-NO	H526-008-NC	H526-008

Note: Flow switches and flow meters sold separately

Ordering information

Fluid media	Flow range		½" NPTF female, swivel brass fitting	½" NPTF female, swivel T303 SS fitting	½" BSPT female, swivel brass fitting	¾" NPTF male, swivel brass fitting	¾" BSPT male, swivel brass fitting	¾" or 1" ① nominal, swivel sweat brass fitting	1" NPTF ② male, plastic polysulfone fitting	1" nominal ③ socket weld PVC fitting	1" NPTF male, swivel PVC fitting	Material	
	gal/min	l/min										Polysulfone	Radel [®] R
Oil 0.876 s.g.	0.5 - 4	2 - 15				H625-704	H630-704		H621-704	H628-704	H629-704	STD	-R
	1.0 - 7	4 - 26	H624-704	H626-704	H627-704	H625-707	H630-707		H621-707	H628-707	H629-707		
	1.0 - 10	4 - 35	H624-707	H626-707	H627-707	H625-710	H630-710		H621-710	H628-710	H629-710		
	1.0 - 16	5 - 60	H624-710	H626-710	H627-710	H625-716	H630-716		H621-716	H628-716	H629-716		
	3.0 - 18	15 - 65	H624-716	H626-716	H627-716	H625-718	H630-718		H621-718	H628-718	H629-718		
	4.0 - 28	20 - 100				H625-728	H630-728		H621-728	H628-728	H629-728		
Water 1.0 s.g.	0.5 - 4	2 - 15				H625-604	H630-604	H620-604	H621-604	H628-604	H629-604	STD	-R
	1.0 - 7	4 - 26	H624-604	H626-604	H627-604	H625-607	H630-607	H620-607	H621-607	H628-607	H629-607		
	1.0 - 10	4 - 35	H624-607	H626-607	H627-607	H625-610	H630-610	H620-610	H621-610	H628-610	H629-610		
	1.0 - 16	5 - 60	H624-610	H626-610	H627-610	H625-616	H630-616	H620-616	H621-616	H628-616	H629-616		
	3.0 - 18	15 - 65	H624-616	H626-616	H627-616	H625-618	H630-618	H620-618	H621-618	H628-618	H629-618		
	4.0 - 28	20 - 100				H625-628	H630-628	H620-628	H621-628	H628-628	H629-628		
Dimensions:	Length ④ in (mm)		7.75 (196.8)	7.75 (196.8)	7.75 (196.8)	8.25 (209.5)	8.25 (209.5)	7.75 (196.8)	5.25 (133.3)	8.46 (214.9)	8.86 (225.0)		
	Fitting flats in (mm)		1.50 (38.1)	1.50 (38.1)	1.50 (38.1)	1.50 (38.1)	1.50 (38.1)	1.50 (38.1)	N/A	1.54 (39.1)	1.50 (38.1)		
	Weight lb (kg)		0.95 (0.43)	0.85 (0.39)	0.95 (0.43)	0.90 (0.41)	0.90 (0.41)	0.75 (0.34)	0.20 (0.09)	0.35 (0.16)	0.55 (0.25)		

① Fits ¾" copper tube types K, L, M; 1" copper tube type M only

② Do not use pipe dope. Use Teflon[®] tape only. Use with plastic fittings only.

③ Fits 1" Sch 40/80 PVC, CPVC pipe. Requires 1" pipe coupling.

④ Length includes end fittings.

Example: Polysulfone model = H 624 - 704 Radel[®] R model = H 624 - 704 -R

EZ-View® flow meters

For oil and water

- 1½ to 2 inch ports
- No special piping or flow straighteners needed
- EZ to install, in any position
- No electrical connections
- Direct reading indication
- Accuracy within ±5% full scale
- Relatively insensitive to shock and vibration

Technical data

Materials	Radel® R plastic body; polysulfone piston and cone T300-series stainless spring Buna N flow indicator ring and pressure seals 360 Brass or PVC fittings Polypropylene limit indicators
Fittings / threads	NPT ANSI/ASME B1.20.1, BSPP ISO228 See ordering information table next page.
Temperature range	0 °C to +121 °C (+32 °F to +250 °F)
Pressure rating	325 psi / 22.4 bar maximum
Pressure drop	See differential pressure chart
Accuracy	±5% of full scale
Repeatability	±1%
Dimensions	See ordering information table next page.



EZ-View® with Radel® R body

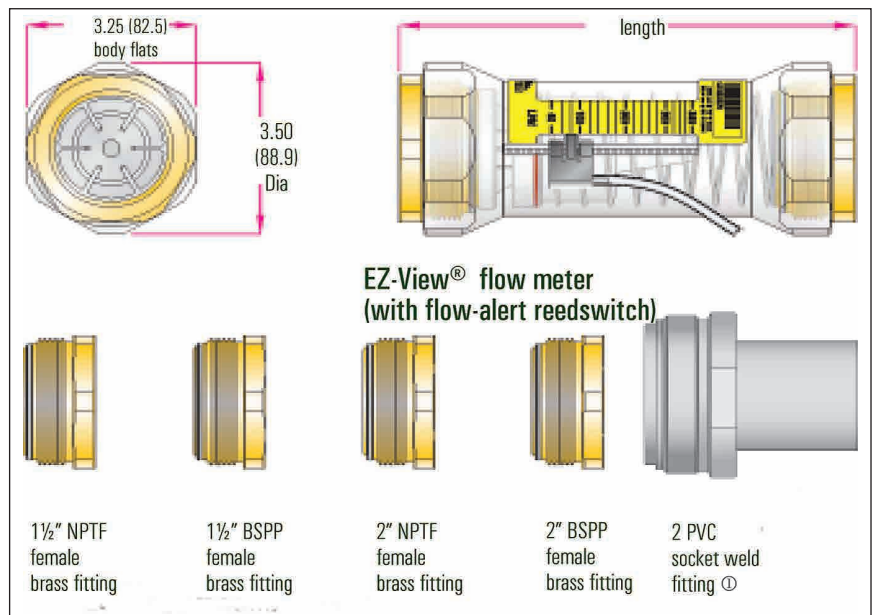

①Meters with type 1 PVC fittings: Pressure rating per normal PVC system specifications.
Temperature range 0 °C to +60 °C (+32 °F to +140°F)

EZ-View[®] flow meters

For oil and water

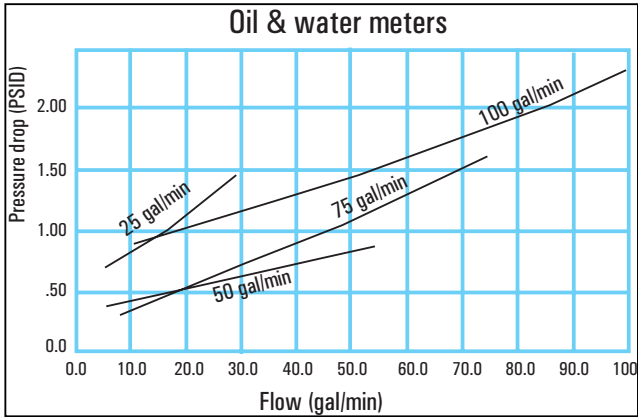

Ordering information

Fluid media	Flow range		1½" NPTF female, brass fitting	1½" BSPP female, brass fitting	2" NPTF female, brass fitting	2" BSPP female, brass fitting	2" PVC socket weld fitting ^①
	gal/min	l/min					
Oil 0.876 s.g.	2 – 25	10 – 95	H615-125-R	H616-125-R	H617-125-R	H618-125-R	
	5 – 50	20 – 190	H615-150-R	H616-150-R	H617-150-R	H618-150-R	
	7 – 75	30 – 280	H615-175-R	H616-175-R	H617-175-R	H618-175-R	
	10 – 100	40 – 380	H615-110-R	H616-110-R	H617-110-R	H618-110-R	
Water 1.0 s.g.	2 – 25	10 – 95	H615-025-R	H616-025-R	H617-025-R	H618-025-R	H619-025-R
	5 – 50	20 – 190	H615-050-R	H616-050-R	H617-050-R	H618-050-R	H619-050-R
	7 – 75	30 – 280	H615-075-R	H616-075-R	H617-075-R	H618-075-R	H619-075-R
	10 – 100	40 – 380	H615-010-R	H616-010-R	H617-010-R	H618-010-R	H619-010-R
Dimensions	Length ^② in (mm)		8.72 (221.5)	8.72 (221.5)	8.72 (221.5)	8.72 (221.5)	11.48 (291.6)
	Fitting Flats in (mm)		3.00 (76.2)	3.00 (76.2)	3.00 (76.2)	3.00 (76.2)	N/A
	Weight lb (kg)		4.10 (1.86)	4.10 (1.86)	3.10 (1.41)	3.10 (1.41)	1.70 (0.77)

① Fits 2" Sch 40/80 PVC, CPVC pipe.

② Length includes end fitting.

EZ-View® flow meters

With Flow-Alert flow switch

- Reed switch and latching models
- Automatically signals alarm, if flow is too high or too low
- Models available for AC or DC power supply
- Latching model includes Hirschmann type electrical connector
- Easy to install
- Easy flow limit adjustment
- Operates in any position
- Relatively insensitive to shock and vibration
- Repeatability within $\pm 1\%$
- Low cost

Technical data

Materials	Radel® R plastic body; polysulfone piston and cone T300-series stainless spring Buna N flow indicator ring and pressure seals C360 brass or PVC fittings Polypropylene limit indicators Strontium ferrite magnet
Fittings / threads	NPT ANSI/ASME B1.20.1, BSPP ISO228 See ordering information table next page.
Temperature range	0 °C to +121 °C (+32 °F to +250 °F)
Pressure rating	325 psi / 22.4 bar maximum
Pressure drop	See differential pressure chart, page 62.
Accuracy	$\pm 5\%$ of full scale
Repeatability	$\pm 1\%$
Dimensions	See ordering information table next page.



EZ-View® with Radel® R body

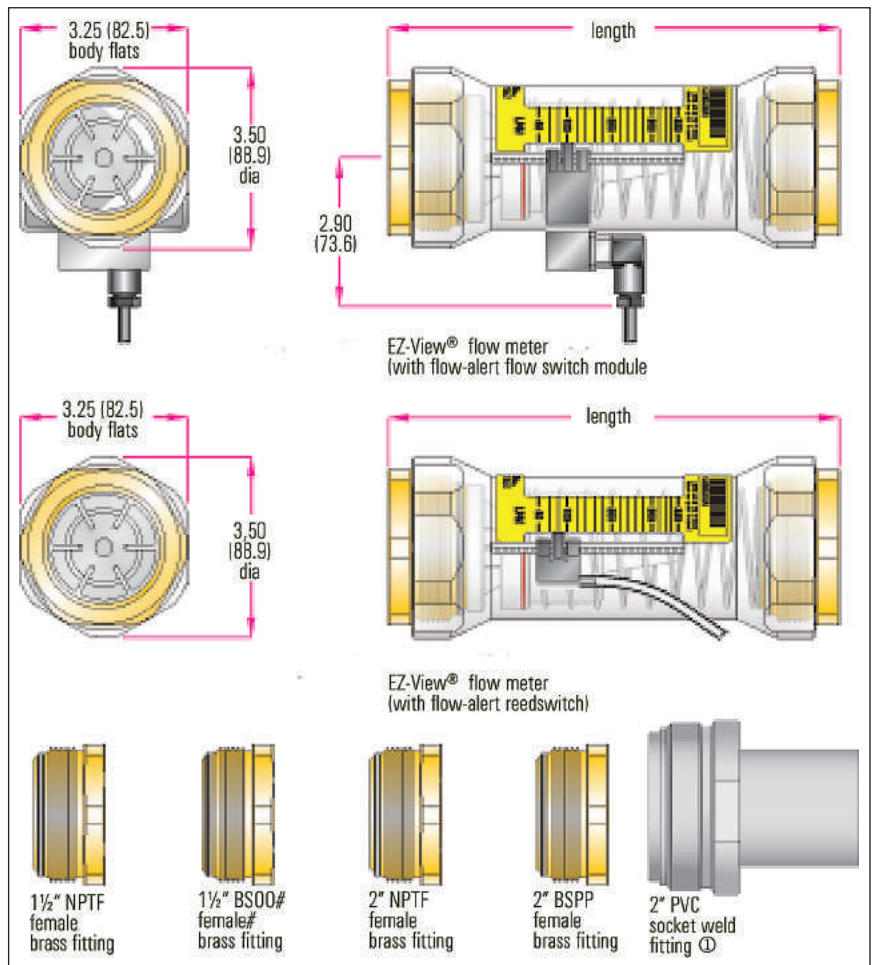

① Meters with type 1 PVC fittings: Pressure rating per normal PVC system specifications.
Temperature range 0 °C to +60 °C (+32 °F to +140 °F)

EZ-View[®] flow meters

With Flow-Alert flow switch

Flow switch options and specifications

The AC and DC powered Flow-Alert flow switch modules consist of a latching relay circuit housed in a sealed polypropylene enclosure. The modules have a normally open dry relay contact that can be used to directly control alarms, warning lights, relays or be used to interface to a PLC. The relay will be latched on as the magnet inside the flow meter passes by the module, and remain latched on until the magnet passes in the other direction or power is interrupted. The set point is adjustable from 0 to 100 % of full scale.

The reed switch Flow-Alert modules are housed in a sealed polypropylene enclosure. The reed switch module does not provide the latching function like the AC and DC powered units. When the magnet inside the flow meter comes within proximity of the module, the reed switch will change state. The set point is adjustable from 0 to 100 % full scale. Two reed switches providing low flow and high flow set points may be installed on a single flow meter.

	AC latching	DC latching
Operating voltage	115 VAC ± 10%	10-30 VDC
Operating current	25 mA maximum	25 mA maximum
Contact rating	1A @ 30 VDC 0.5A @ 125 VAC Resistive load	1A @ 30 VDC 0.5A @ 125 VAC Resistive load
Operating temperature	+32 to +158 °F (0 to +70 °C)	+32 to +158 °F (0 to +70 °C)
Connector	4-pin connector (protection class IP65)	4-pin connector (protection class IP65)
Cable	Not included	Not included
Rating	NEMA 12 & 13 (IP65)	NEMA 12 & 13 (IP65)
Certification	N/A	EMC directive 89/336/EEC
Model number	H526-004	H526-006

Reed switch form-A normally open (NO)	Reed switch form-B normally closed (NC)	Reed switch form-C
-	-	-
-	-	-
1A max 200 VDC max 15 watts max Resistive load	0.25A max 175 VDC max 5 Watts max Resistive load	0.25A max 175 VDC max 5 watts max Resistive load
+32 to +250 °F (0 to +121 °C)	+32 to +250 °F (0 to +121 °C)	+32 to +250 °F (0 to +121 °C)
-	-	-
3 foot, 2-wire #24 AWG black PVC Jacketed pig-tail	3 foot, 2-wire #20 AWG grey PVC Jacketed pig-tail	3 foot, 3-wire #24 AWG grey PVC Jacketed pig-tail
NEMA 12 & 13 (IP65)	NEMA 12 & 13 (IP65)	NEMA 12 & 13 (IP65)
EMC directive 89/336/EEC	EMC directive 89/336/EEC	EMC directive 89/336/EEC
H526-008-NO	H526-008-NC	H526-008

Note: Flow switches and flow meters sold separately

Ordering information

Fluid media	Flow range		1½" NPTF female, brass fitting	1½" BSPP female, brass fitting	2" NPTF female, brass fitting	2" BSPP female, brass fitting	2" PVC socket weld fitting ^①
	gal/min	l/min					
Oil 0.876 s.g.	2 – 25	10 – 95	H615-725-R	H616-725-R	H617-725-R	H618-725-R	
	5 – 50	20 – 190	H615-750-R	H616-750-R	H617-750-R	H618-750-R	
	7 – 75	30 – 280	H615-775-R	H616-775-R	H617-775-R	H618-775-R	
	10 – 100	40 – 380	H615-710-R	H616-710-R	H617-710-R	H618-710-R	
Water 1.0 s.g.	2 – 25	10 – 95	H615-625-R	H616-625-R	H617-625-R	H618-625-R	H619-625-R
	5 – 50	20 – 190	H615-650-R	H616-650-R	H617-650-R	H618-650-R	H619-650-R
	7 – 75	30 – 280	H615-675-R	H616-675-R	H617-675-R	H618-675-R	H619-675-R
	10 – 100	40 – 380	H615-610-R	H616-610-R	H617-610-R	H618-610-R	H619-610-R
Dimensions	Length ^② in (mm)		8.72 (221.5)	8.72 (221.5)	8.72 (221.5)	8.72 (221.5)	11.48 (291.6)
	Fitting Flats in (mm)		3.00 (76.2)	3.00 (76.2)	3.00 (76.2)	3.00 (76.2)	N/A
	Weight lbs (kg)		4.10 (1.86)	4.10 (1.86)	3.10 (1.41)	3.10 (1.41)	1.70 (0.77)

① Fits 2" Sch 40/80 PVC, CPVC pipe.

② Length includes end fitting.

Note: Flow switches and flow meters sold separately

EZ-View[®] flow meters

In-Line test kits

- Simultaneously monitors in-line flow & pressure
- Compact & self-contained
- Mounts in any position
- Easily carried in tool kit

Here is a convenient, low-cost diagnostic tool to help you check flow and pressure simultaneously. The EZ-View[®] in-line test kits were designed to measure flow from 0.5 to 28 GPM (2 to 106 l/min), and operating pressures up to 160 psi (11 bar).

This compact, self-contained unit is easy to install, and can be used as a permanent monitoring indicator, or as a temporary troubleshooting tool to help: Check pump leakage under load, verify proper flow, pressure or control settings, locate line restrictions, verify pressure drops and balance multi-line systems.



EZ-View[®] with Polysulfone body



EZ-View[®] with Radel[®] R body

Ordering information

Fluid media	Flow range		1" NPTF male/female fitting	
	gal/min	l/min	Polysulfone	Radel [®] R
Oil 0.876 s.g.	0.5 - 4	3 - 13	H623-104	H623-104-R
	1.0 - 7	2 - 26	H623-107	H623-107-R
	1.0 - 10	5 - 40	H623-110	H623-110-R
	1.0 - 16	5 - 60	H623-116	H623-116-R
	3.0 - 18	10 - 70	H623-118	H623-118-R
Water 1.0 s.g.	4.0 - 28	20 - 100	H623-128	H623-128-R
	0.5 - 4	3 - 16	H623-004	H623-004-R
	2.0 - 7	4 - 26	H623-007	H623-007-R
	2.0 - 10	5 - 35	H623-010	H623-010-R
	6.0 - 16	5 - 60	H623-016	H623-016-R
	4.0 - 18	15 - 65	H623-018	H623-018-R
	4.0 - 28	20 - 100	H623-028	H623-028-R

Weight lbs (kg) 0.80 (0.36)

Technical data

Materials	Polysulfone plastic body, piston and cone Radel [®] R plastic body and cone, polysulfone piston
Common parts	
Spring	T300-series stainless
Indicator ring	Buna N
Pressure seals	Buna N
Fittings	C360 brass, PVC, or T303 stainless steel
Limit indicators	Polypropylene
Retaining ring	PH15 - 7MO stainless
Optional (consult factory)	
Spring and retaining ring	Teflon [®] coated
Load valve	Polyvinyl chloride (PVC) - 1 body Polypropylene ball Teflon [®] ball seat Ethylene propylene (EPDM) O-ring
Fittings / threads	
Flow meter	NPT - 1 inch male / ANSI/ASME B1.20.1
Load valve:	NPT - 1 inch female / ANSI/ASME B1.20.1
Temperature range	0 °C to +65 °C (+32 °F to +150 °F)
Pressure rating	325 psi / 22.4 bar maximum
Pressure gauge	0 to 160 psi (0 to 11.0 bar) with internal shock damp
Pressure drop	See differential pressure chart, page 62.
Accuracy	±5% of full scale
Repeatability	±1%

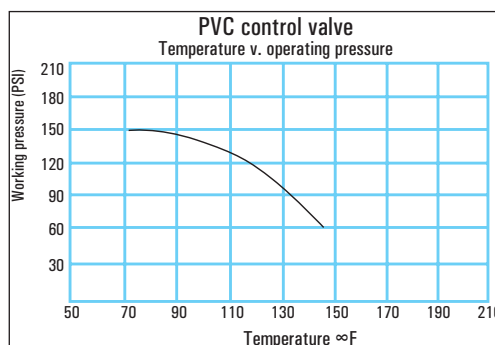
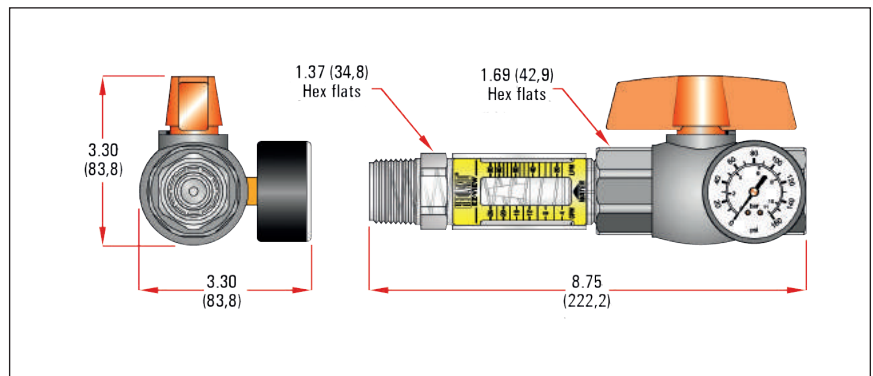

Dimensional information

For standard 1½ inch C62, 3 inch; SAE, NPTF, BSPP and 3 inch C61

1½ inch; C62 flange - Inches (mm)

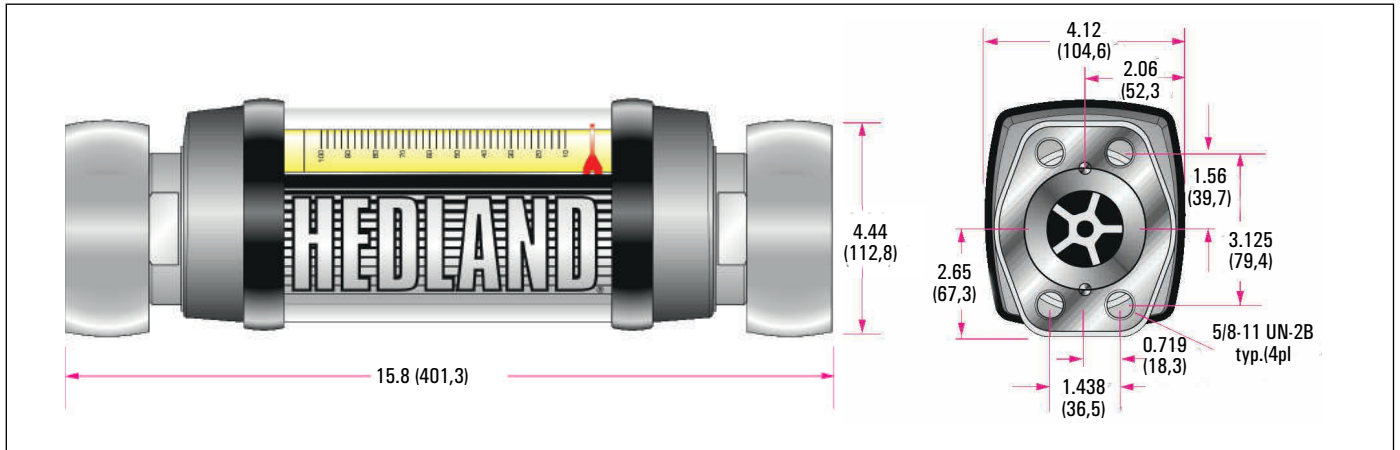

3 inch; NPTF, BSPP - Inches (mm)

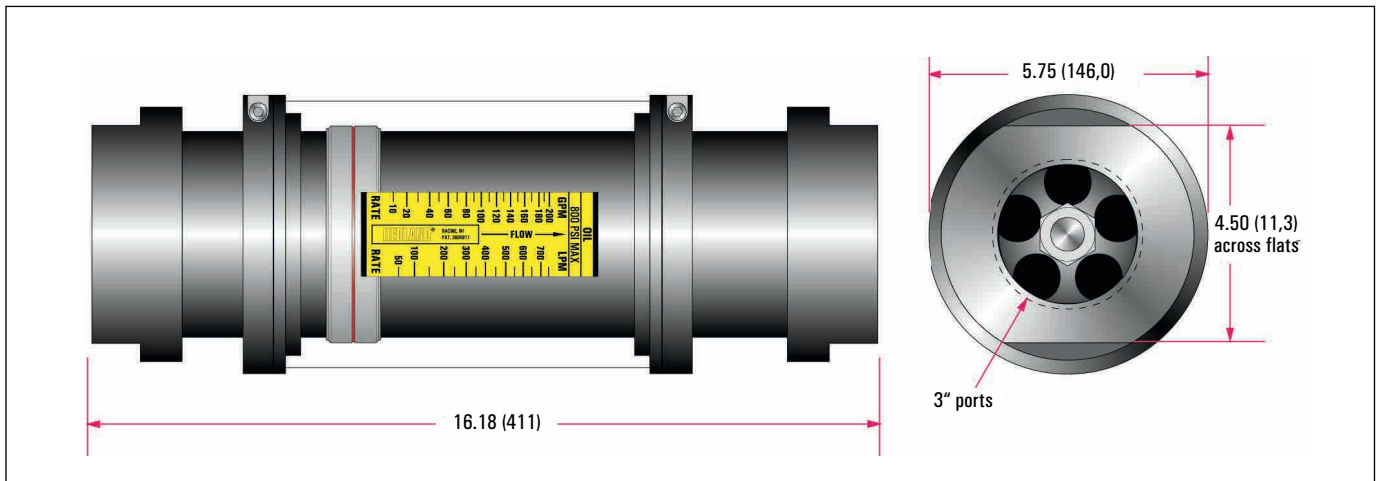

3 inch; C61 flange - Inches (mm)

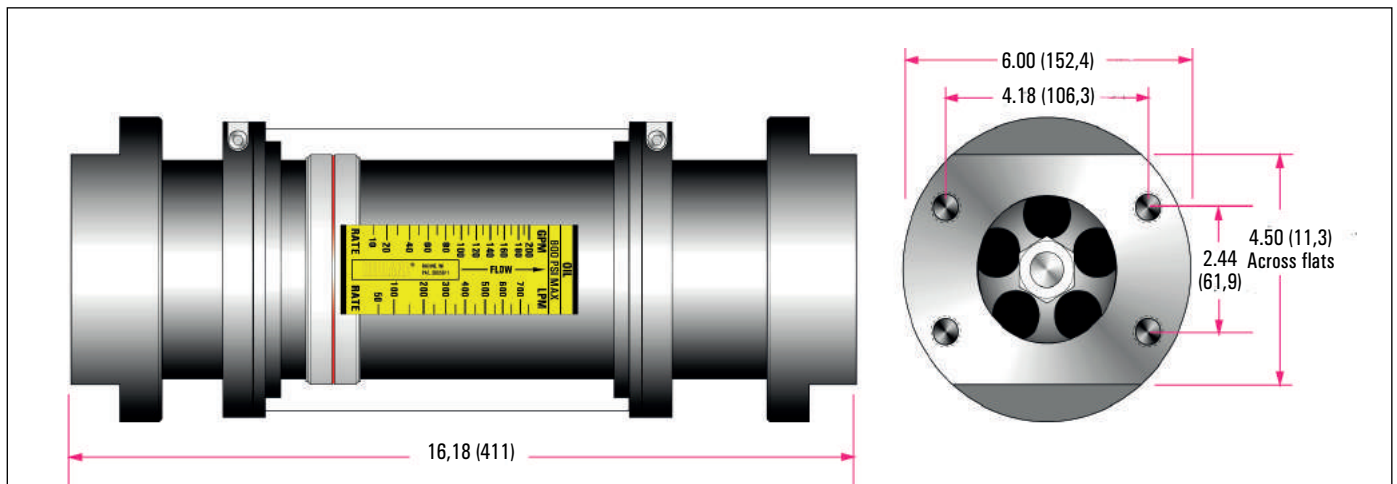

Weights for all flow meter models	Aluminium with aluminum internals	Brass with brass internals	T303 SS with aluminum internals	T303 SS with brass internals	T316 SS with T316 SS internals	Hostile environment T316 SS with T316 internals lbs (kg)
	lbs (kg)	lbs (kg)	lbs (kg)	lbs (kg)	lbs (kg)	lbs (kg)
¼" Standard meter	.55 (.25)	1.05 (.48)	.9 (.41)	1.05 (.48)	~	~
¼" High temperature	1.35 (.61)	2.75 (1.25)	CF	2.75 (1.25)	2.75 (1.25)	~
¼" API oil, caustic & corrosive liquids & gases	~	~	~	~	3.00 (1.36)	3.00 (1.36)
¼" Pneumatic meter with extended cap	.7 (.32)	1.6 (.73)	1.5 (.68)	~	~	~
¼" Pneumatic meter with extended cap with gauge	1.2 (.55)	2.1 (1.0)	2.0 (.91)	~	~	~
Test kit with extended cap/gauge/valve	1.6 (.73)	2.5 (1.2)	2.3 (1.1)	~	~	~
¼" Flow-Alert flow switch	4.30 (1.95)	5.65 (2.56)	5.15 (2.34)	5.50 (2.50)	5.80 (2.63)	~
¼" Flow transmitter	4.25 (1.93)	5.60 (2.54)	5.10 (2.31)	5.45 (2.47)	5.75 (2.61)	~
½" Standard meter	1.25 (.57)	2.60 (1.18)	2.1 (.95)	2.45 (1.11)	~	~
½" Liquid test kit	4.9 (2.2)	5.7 (2.6)	5.3 (2.4)	~	~	~
½" High temperature	1.35 (.61)	2.75 (1.25)	CF	2.75 (1.25)	2.75 (1.25)	~
½" API oil, caustic & corrosive liquids & gases	3.0 (1.4)	~	~	~	2.95 (1.34)	2.95 (1.34)
½" Pneumatic meter with extended cap	2.1 (1.0)	3.8 (1.7)	3.3 (1.5)	~	~	~
½" Pneumatic meter with extended cap with gauge	2.7 (1.2)	4.3 (2.0)	3.8 (1.7)	~	~	~
Test kit with extended cap/gauge/valve	3.2 (1.5)	4.8 (2.2)	4.3 (2.0)	~	~	~
½" Flow-Alert flow switch	4.30 (1.95)	5.65 (2.56)	5.15 (2.34)	5.50 (2.50)	5.80 (2.63)	~
½" Flow transmitter	4.25 (1.93)	5.60 (2.54)	5.10 (2.31)	5.45 (2.47)	5.75 (2.61)	~
¾" Standard meter	2.0 (.9)	4.0 (1.8)	3.5 (1.6)	3.9 (1.8)	~	~
¾" Liquid test kit	7.0 (3.2)	9.0 (4.1)	8.5 (3.9)	~	~	~
¾" High temperature	2.1 (1.0)	4.40 (2.00)	4.00 (1.81)	4.40 (2.00)	4.40 (2.00)	~
¾" API oil, caustic & corrosive liquids & gases	~	~	~	~	4.40 (2.00)	4.6 (2.1)
¾" Pneumatic meter with extended cap	3.0 (1.4)	6.6 (3.0)	6.2 (2.8)	~	~	~
¾" Pneumatic meter with extended cap with gauge	3.5 (1.6)	7.1 (3.2)	6.7 (3.1)	~	~	~
Test kit with extended cap/gauge/valve	4.4 (2.0)	7.9 (3.6)	7.5 (3.4)	~	~	~
¾" Flow-Alert flow switch	4.95 (2.25)	6.95 (3.15)	6.60 (3.00)	6.85 (3.11)	7.35 (3.33)	~
¾" Flow transmitter	CF	CF	CF	CF	CF	~
1" Standard meter	1.85 (.84)	3.75 (1.70)	2.7 (1.3)	3.4 (1.5)	~	~
1" Liquid test kit	6.8 (3.1)	8.7 (4.0)	7.7 (3.5)	~	~	~
1" High temperature	3.0 (1.4)	4.40 (2.00)	4.00 (1.81)	4.40 (2.00)	4.40 (2.00)	~
1" API oil, caustic & corrosive liquids & gases	~	~	~	~	4.40 (2.00)	4.60 (2.10)
1" Pneumatic meter with extended cap	2.8 (1.3)	6.3 (2.9)	5.4 (2.5)	~	~	~
1" Pneumatic meter with extended cap with gauge	3.3 (1.5)	6.8 (3.1)	5.9 (2.7)	~	~	~
Test kit with extended cap/gauge/valve	4.2 (1.9)	7.6 (3.5)	6.7 (3.1)	~	~	~
1" Flow-Alert flow switch	4.95 (2.25)	6.85 (3.11)	5.80 (2.63)	6.50 (2.95)	7.50 (3.40)	~
1" Flow transmitter	CF	CF	CF	CF	CF	~
1¼" Standard meter	7.3 (3.3)	16.8 (7.6)	14.6 (6.6)	16.8 (7.6)	~	~
1¼" Liquid test kit	18.7 (8.5)	28.2 (12.8)	26.0 (11.8)	~	~	~
1¼" High temperature	9.6 (4.4)	21.40 (9.71)	CF	21.40 (9.71)	21.40 (9.71)	~
1¼" API oil, caustic & corrosive liquids & gases	~	~	~	~	21.40 (9.71)	CF
1¼" Pneumatic meter with extended cap	9.9 (4.5)	24.3 (11.0)	21.1 (9.6)	~	~	~
1¼" Pneumatic meter with extended cap with gauge	10.4 (4.7)	24.8 (11.2)	21.7 (9.8)	~	~	~
Test kit with extended cap/gauge/valve	12.5 (5.7)	27.0 (12.3)	23.8 (10.8)	~	~	~
1¼" Flow-Alert flow switch	13.55 (6.15)	23.05 (10.46)	20.85 (9.46)	23.05 (10.46)	27.65 (12.54)	~
1¼" Flow transmitter	CF	CF	CF	CF	CF	~
1½" Standard meter	7.3 (3.3)	16.4 (7.5)	14.1 (6.4)	15.8 (7.2)	~	~
1½" Standard meter with C62 flange	19.0 (8.6)	28.2 (12.8)	25.8 (11.7)	~	~	~
1½" Liquid test kit	18.7 (8.5)	27.8 (12.6)	25.5 (11.6)	~	~	~
1½" High temperature	9.6 (4.4)	21.40 (9.71)	CF	21.40 (9.71)	21.40 (9.71)	~
1½" High temperature with C62 flange	CF	21.8 (9.9)	CF	CF	CF	~
1½" API oil, caustic & corrosive liquids & gases	~	~	~	~	21.40 (9.71)	CF
1½" Pneumatic meter with extended cap	9.9 (4.5)	23.9 (10.8)	20.6 (9.4)	~	~	~
1½" Pneumatic meter with extended cap with gauge	10.4 (4.7)	24.4 (11.1)	21.2 (9.6)	~	~	~
Test kit with extended cap/gauge/valve	12.5 (5.7)	26.6 (12.1)	23.3 (10.6)	~	~	~
1½" Flow-alert flow switch	13.55 (6.15)	22.65 (10.27)	20.35 (9.23)	22.05 (10.00)	27.65 (12.54)	~
1½" Flow transmitter	CF	CF	CF	CF	CF	~
3" Standard meter	17.5 (8.0)	52.5 (23.8)	~	~	~	~
3" Standard meter with C61 flange	20.0 (9.1)	55.0 (25.0)	~	~	~	~

~ : Not available as standard option

CF: Consult factory for weights



Badger Meter Europa

innovative. precise. sustainable.

Every drop counts.

Badger Meter Europa GmbH
Nürtinger Str. 76
72639 Neuffen
Germany
Tel. +49-70 25-92 08-0
Fax +49-70 25-92 08-15
badger@badgermeter.de
www.badgermeter.de

For Switzerland
Remag AG
Mess- und Regeltechnik
Mittelholzerstr. 8
3006 Bern
Schweiz
Tel. +41-31-93 20 111
Fax +41-31-93 10 867
info@remag.ch
www.remag.ch

For the USA and Canada
Badger Meter, Inc.
P.O. Box 245036
Milwaukee, WI 53224-9536
USA
Tel. +1-414-355-04 00
Fax +1-414-355-74 99
infocentral@badgermeter.com
www.badgermeter.com

For Asia
Badger Meter Europa GmbH
Singapore Branch
80 Marine Parade Road
#21-06 Parkway Parade
Singapore 449269
Singapore
Tel. +65-63 46 48 36
Fax +65-63 46 48 37
awang@badgermeter.com

For Slovakia
Badger Meter Slovakia s. r. o.
Racianska 109 / B
83102 Bratislava
Slovakia
Tel. +421-2-44 63 83 01
Fax +421-2-44 63 83 03
badgermeter@badgermeter.sk
www.badgermeter.sk

For the United Arab Emirates
Badger Meter Europe
Middle East Branch Office
Dubai Silicon Oasis
Head Quarter Building
Wing C, Office #C209
Dubai / UAE
Tel. +971-4-371 2503
Fax +971-4-371 2504
gramaswamy@
badgermeter.com

For Mexico
Badger Meter de las
Americas S. A. de C. V.
Pedro Luis Ogazon #32
Col. Guadalupe Inn
Mexico, D. F. 01020
Mexico
Tel. +52-55-56 62-08 82
Fax +52-55-56 62-75 81
bmdla@badgermeter.com

For China
Badger Meter, Inc.
Shanghai Representative
Office 7-1202
99 Hangzhong Road
Minhang District
Shanghai 201101
China
Tel. +86-21-57 63-54 12
Fax +86-21-57 63-54 12
rjiang@badgermeter.com

For the Czech Republic
Badger Meter Czech
Republic s. r. o.
Marikova 2082/26
62100 Brno
Czech Republic
Tel. +420-5-41 42 04 11
Fax +420-5-41 22 97 24
itomas@badgermeter.cz
www.badgermeter.cz